

HOUSEHOLD SCALE SLOW SAND FILTRATION IN THE DOMINICAN REPUBLIC

By

Kori S. Donison

SB Civil and Environmental Engineering
Massachusetts Institute of technology, 2003

Submitted to the Department of Civil and Environmental Engineering
In Partial Fulfillment of the Requirements of the Degree of

MASTER OF ENGINEERING
In Civil and Environmental Engineering
at the

MASSACHUSETTS INSTITUTE OF TECHNOLOGY
JUNE 2004

©2004 Kori Donison
All rights reserved.

The author hereby grants M.I.T. permission to reproduce and to distribute publicly paper and
electronic copies of this thesis document in whole and in part.

Signature of Author _____
Department of Civil and Environmental Engineering
May 17, 2004

Certified by _____
Susan Murcott
Thesis Supervisor
Lecturer, Department of Civil and Environmental Engineering

Certified by _____
Heather Lukacs
Thesis Supervisor
Lecturer, Department of Civil and Environmental Engineering

Accepted by _____
Oral Buyukozturk
Professor of Civil and Environmental Engineering
Chairman Department Committee on Graduate Studies

HOUSEHOLD SCALE SLOW SAND FILTRATION IN THE DOMINICAN REPUBLIC

by

Kori S. Donison

Submitted to the Department of Civil and Environmental Engineering on May 17, 2004 in partial fulfillment of the requirements of the degree of Master of Engineering in Civil and Environmental Engineering.

Abstract

Slow sand filtration is a method of water treatment that has been used for hundreds of years. In the past two decades, there has been resurgence in interest in slow sand filtration, particularly as a low-cost, household-scale method of water treatment. During January 2004, the author traveled to the northwestern Dominican Republic to evaluate the performance of BioSand filters installed over the past two years. BioSand filter performance was evaluated based on flow rate, turbidity removal and total coliform removal in communities surrounding the cities of Mao, Puerto Plata and Dajabon. Filter owners were interviewed about general filter use, water storage methods, filter maintenance practices, and water use.

Data analysis revealed that even though the majority of filters were removing large portions of both total coliform and *E. coli* contamination, no filters met the WHO water quality guideline of less than one CFU/100 ml. Analysis also revealed that at low turbidities, turbidity removal and total coliform removal are not correlated. Examination of flow rate and bacterial removal near Puerto Plata revealed that filters with fast flow rates and intermittent chlorination were observed to have the lowest total coliform removal rates. Analysis of storage data revealed that failure to use safe water storage containers leads to recontamination of filtered water.

During Spring of 2004, a laboratory was conducted to examine longer-term thermotolerant coliform and turbidity removal. The study compared removal rates between two BioSand filters, one of which was paired with a geotextile prefilter used in the construction of the Peruvian Table Filter. The study revealed that thermotolerant coliform removal rates by the BioSand filter without the geotextile stabilized after an initial period of lower bacterial removal efficiency. Thermotolerant coliform removal in the BioSand filter with the geotextile prefilter dropped throughout the experiment, suggesting that pairing a BioSand filter with a prefilter is detrimental to filter performance.

Combining the results of the survey analysis and data gathered in the Dominican Republic with the results of the laboratory analysis of Spring 2004 suggests that BioSand filter users in the Dominican Republic should continue to use their filters. If possible, BioSand filter use should be combined with post-filtration chlorination to kill the remaining bacteria. The BioSand filter is a valuable and effective household-scale water treatment method for the Dominican Republic.

Thesis Supervisor: Susan Murcott.

Thesis Supervisor: Heather Lukacs

Titles: Lecturers, Department of Civil and Environmental Engineering

Acknowledgements

I dedicate this thesis to my grandfather Robert VanDerhoef. He was a kind man with a great sense of humor, and I couldn't have imagined a better grandfather. Grandpa Bob, I miss you and I wish you were here to see me graduate with my Masters of Engineering. I know you would have been proud.

I would like to thank those people who have helped me and kept me sane during the last nine months. I would first like to thank my mother and father, Terry and Anthony Donison, both of whom have always encouraged me to work my hardest and do my best as well as providing me with anecdotes about their respective graduate experiences. I would also like to thank my friend and housemate Chandra Claycamp, with whom I have spent many an evening and weekend studying and working on our dilapidated couch.

Special thanks go to all who helped make this thesis possible: Susan Murcott, my thesis advisor; Heather Lukacs and Teresa Yamana, my DR research buddies; Dr. Jan Tollefson, the organizer of our January trip; and our various hosts and friends from the Dominican Republic including Juan Bencosme and family, José Rivas and family, Anyelo Minier, and Robert Hildreth and family.

Table of Contents

| | |
|-------------------------------------------------------------------------------|----|
| 1 Introduction | |
| 1.1 Background Statistics..... | 8 |
| 1.2 Causes of Waterborne Diseases..... | 8 |
| 1.3 Project Goal..... | 11 |
| 2 Slow Sand Filtration | |
| 2.1 Slow Sand Filtration: Historical Background..... | 12 |
| 2.2 Basic Design Elements of Slow Sand Filters..... | 13 |
| 2.3 Mechanisms of Contaminant Removal in Slow Sand Filters..... | 16 |
| 2.4 Additional Variables Influencing Filter Performance..... | 18 |
| 2.4.1 Water Temperature..... | 18 |
| 2.4.2 Influent Water Composition..... | 19 |
| 3 The BioSand Filter | |
| 3.1 Household-Scale Slow Sand Filtration..... | 20 |
| 3.2 BioSand Filter History..... | 20 |
| 3.3 Advantages and Disadvantages of Household-Scale Slow Sand Filtration..... | 21 |
| 3.4 BioSand Design..... | 22 |
| 3.5 BioSand Filter Construction and Installation..... | 23 |
| 3.5.1 Filter Construction..... | 23 |
| 3.5.2 Filter Installation..... | 26 |
| 3.6 Maintenance and Cleaning Procedures..... | 27 |
| 4 Pretreatment Options for Slow Sand Filtration | |
| 4.1 Shading..... | 29 |
| 4.2 Sedimentation and Storage..... | 30 |
| 4.3 Cloth Filtration..... | 30 |
| 4.4 Roughing Filters..... | 31 |
| 4.5 Prechlorination..... | 32 |
| 4.6 Ozonation..... | 32 |
| 5 Site Description | |
| 5.1 The Dominican Republic..... | 34 |
| 5.2 Mao, Hundidera and Los Martinez..... | 35 |
| 5.3 Dajabon, Cajuco and Las Matas de Santa Cruz..... | 35 |
| 5.4 Playa Oeste, Los Dominguez and Javillar de Costambar..... | 36 |
| 5.5 Filter Cost..... | 37 |
| 6 Methods | |
| 6.1 Sample Collection..... | 39 |
| 6.1.1 Sample Collection in the Dominican Republic..... | 39 |
| 6.1.2 Sample Collection at MIT..... | 39 |
| 6.2 Membrane Filtration..... | 40 |
| 6.3 Incubation..... | 41 |
| 6.4 Duplicates and Blanks..... | 42 |
| 6.5 Sterilization..... | 42 |
| 6.5.1 Glassware..... | 42 |
| 6.5.2 Pipette Tips..... | 42 |
| 6.5.3 Stainless Steel Funnel Sterilization..... | 43 |

| | | |
|-------|-------------------------------------------------------------------------------|----|
| 6.6 | Turbidity..... | 43 |
| 6.7 | Flow Rate..... | 43 |
| 6.8 | Bacterial Disposal..... | 44 |
| 6.9 | Interview Methods..... | 44 |
| 7 | Quantitative Results | |
| 7.1 | Bacterial Plate Count Analysis..... | 46 |
| 7.1.1 | Source Water <i>E. coli</i> and Total Coliform Counts..... | 47 |
| 7.1.2 | Filtered Water Total Coliform and <i>E. coli</i> Counts, Percent Removal..... | 49 |
| 7.1.3 | Stored Water Total Coliform Counts..... | 51 |
| 7.2 | Flow Rates..... | 53 |
| 7.3 | Turbidity Removal..... | 54 |
| 7.3.1 | Source Water and Filtered Water Turbidity..... | 54 |
| 7.3.2 | Pause Water Turbidity..... | 58 |
| 8 | Qualitative Data Analysis: Survey Results | |
| 8.1 | Background Observations..... | 59 |
| 8.2 | Water Sources and Filter Use..... | 61 |
| 8.2.1 | Water Sources..... | 61 |
| 8.2.2 | Water Treatment Previous to Purchasing the BioSand Filter..... | 62 |
| 8.2.3 | Filter Age..... | 62 |
| 8.2.4 | Filtered Water Uses..... | 62 |
| 8.3 | Filter Maintenance and Water Storage..... | 63 |
| 8.4 | Reported Health Effects..... | 64 |
| 9 | Laboratory Study | |
| 9.1 | Introduction..... | 70 |
| 9.2 | Setup..... | 71 |
| 9.3 | Procedures..... | 72 |
| 9.4 | Results..... | 73 |
| 9.4.1 | Turbidity Removal..... | 73 |
| 9.4.2 | Thermotolerant Coliform Removal..... | 74 |
| 10 | Conclusions | |
| 10.1 | Percent Removal vs. Total Coliform Count..... | 77 |
| 10.2 | <i>E. coli</i> Removal..... | 77 |
| 10.3 | High Flow Rate and Intermittent Chlorination..... | 78 |
| 10.4 | Storage..... | 79 |
| 10.5 | Laboratory Study..... | 80 |
| 10.6 | Recommendations..... | 80 |
| | Works Cited..... | 81 |
| | Appendix A..... | 84 |
| | Appendix B..... | 85 |
| | Appendix C..... | 87 |
| | Appendix D..... | 89 |
| | Appendix E..... | 91 |
| | Appendix F..... | 95 |

Equations, Tables and Figures

Equation 7.1: Percent Removal.

Table 1.1: Waterborne Pathogens and Their Significance in Water Supplies. Source: WHO 1993.
Table 2.1: Selected Criteria for Slow Sand Filter Design. Adapted from Pyper and Logsdon 1991.
Table 5.1: Filter Location, Cost and Funding Information.
Table 7.1: Source Water *E. coli* and Total Coliform Counts. January 2004.
Table 7.2: Total Coliform and *E. coli* Counts in Source Waters and Filtered Waters. January 2004.
Table 7.3: Source, Filtered and Stored Water Total Coliform Contamination. January 2004.
Table 7.4: Source, Filtered and Stored Water *E. coli* Contamination. January 2004.
Table 7.5: Average, Standard Deviation and Range of Flow Rates. January 2004.
Table 7.6: Average, Standard deviation and Range of Flow Rates near Mao. January 2004.
Table 7.7: Filter-Specific Pause, Source and Filtered Water Turbidity. January 2004.
Table 7.8: Average Source Water Turbidity, Average Filtered Water Turbidity, and Average Turbidity Percent Removal Rates. January 2004.
Table 7.9: Average Pause Water Turbidity. January 2004.
Table 8.1: Number of Interviews per Site and Family Age Distribution by Location. January 2004.
Table 8.2: General Quality of Life Observations: Latrine Type, Floor Type and Transportation Type.
Table 8.3: Water Sources, Filter Characteristics and Comparisons of Post and Pre-BioSand Filter Water Effects. January 2004.
Table 8.4: BioSand Filter and Storage Vessel Maintenance. January 2004.
Table 9.1: Spring 2004 Laboratory Turbidity and Percent Removal Data.
Table 9.2: Source Water and Filtered Water Thermotolerant Coliform Contamination and Percent Removal.
Table 10.1: Filter Affect on *E. coli* Concentration.

Figure 2.1: Typical Slow Sand Filter. Adapted From: IRC/WHO, 1978 (as seen at <http://ces.iisc.ernet.in/energy/water/paper/drinkingwater/simplemethods/filtration.html>)
Figure 3.1: BioSand Filter Schematic. Image Source: www.friendswhocare.ca/FWCpage2A.htm
Figure 3.2: PVC Pipe Assembly.
Figure 3.3: BioSand filter molds. The outer mold (left) shows the placement of the pipe assembly in gray, and the inner mold has a hole where the pipe assembly should be connected. Source: DAVNOR.
Figure 3.4: A diffuser plate inside a BioSand Filter. Source: Heather Lukacs.
Figure 4.1: Pore size differences in new and old cotton sari fabric. Source: PNAS 100(3): p. 1052.
Figure 5.1: Map of the Dominican Republic. January 2004 Sites Boxed. Source: National Geographic Society.
Figure 5.2: Typical scene in Hundidera, Dominican Republic.
Figure 5.3: Crossing the Border between the Dominican Republic and Haiti.
Figure 5.4: Typical Home in the hills near Puerto Plata.
Figure 6.1: Team member Jeff Cerilles inspects the head space of a BioSand filter.
Figure 6.2: Membrane Filtration Apparatus.
Figure 6.3: Portable Millipore Incubator.
Figure 7.1: Total Coliform and *E. coli* Contamination in Dominican Source Waters. January 2004.
Figure 7.2: Total coliform and *E. coli* Contamination in Filtered Waters in the Dominican Republic.
Figure 7.3: Total Coliform plates from 10 ml of source water, 100 ml of filtered water, and 100 ml of stored water in Mao, Dominican Republic, January 9, 2004.
Figure 7.4: Flow Rates Measured During Field Work in the Dominican Republic, January 2004.
Figure 7.5: Source Water Turbidity Distribution (n=43 filters). January 2004.
Figure 7.6: Filtered Water Turbidity Distribution (n=43 filters). January 2004.
Figure 8.1: Bathroom Facility Types Observed in the Dominican Republic. January 2004.
Figure 8.2: Floor Types Observed in the Dominican Republic. January 2004.
Figure 8.3: Secondary Uses of Water Treated by the BioSand Filter in the Dominican Republic.
Figure 8.4: Storage Vessels Seen in the Dominican Republic. January 2004.
Figure 9.1: Sand Bed Location in the Table Filter (left) and the BioSand Filter (right).
Figure 9.2: BioSand filters setup during laboratory experimentation.

Figure 9.3: Growth in the BioSand filter's head space. Left: Without geotextile. Right: With geotextile. March 7, 2004.

Figure 9.4: Turbidity Concentrations in Source and Filtered Water. Spring 2004.

Figure 10.1: Safe Water Storage Container in the Dominican Republic. January 2004.

1 Introduction

1.1 Background Statistics

Each year, 3.4 million people worldwide (many of them children) die from water, sanitation and hygiene related diseases (WHO, 2000). Six thousand children die each day from diarrhea, which is often caused by fecal contamination of water sources. The majority of these children are under the age of five (WHO, 2000). Many of these people are undoubtedly among the 1.1 billion people who lack access to improved water sources. At the World Summit on Sustainable Development in September 2002, world leaders set a goal of halving the number of people without sustainable access to clean water by 2015.

1.2 Microorganisms that Cause of Waterborne Disease

Waterborne sicknesses are caused by a wide variety of organisms. These disease-causing organisms, or pathogens, include bacteria, viruses, protozoa and helminths. Many of these organisms cause diarrhea, resulting in a debilitating loss of water from the body. Diarrhea causes 4% of deaths worldwide (WHO, undated).

The term “bacteria” refers to the group of prokaryotes of the Bacteria Kingdom. Prokaryotes, by definition, are living, single-celled organisms containing very few cellular structures. Bacteria range from 0.1 to 50 μm in diameter (Madigan et al., 2000). Bacteria that cause waterborne sicknesses include *Salmonella*, *V. cholerae*, and *Shigella*. Sicknesses caused by these organisms include salmonella, cholera and soft tissue infections (WHO, 1997).

Viruses are not considered living organisms. They are genetic elements that can replicate independently of a cell’s chromosome, but not independently of the cell itself. Viruses are typically much smaller than cells, ranging from 0.02 to 0.3 μm (Madigan et al., 2000). Viruses known to cause waterborne sicknesses include hepatitis, enteroviruses, adenoviruses and rotoviruses. Sicknesses caused by these organisms include gastroenteritis and Hepatitis A and E (WHO, 1997).

Protozoa are eukaryotic organisms. Like bacteria, protozoa are single-celled organisms. Protozoa lack the chlorophyll of algae, and are larger than viruses and bacteria. Some types of

protozoa are large enough to be seen with the naked eye. *Paramecium* cells, for example, are 60 µm in length (Madigan et al., 2000). Protozoa can cause dysentery and suppression of the immune system (WHO, 1997).

Helminths are worms (parasitic and non-parasitic). Three main types of helminths cause disease in humans: tapeworms, roundworms and flukes. Guinea worm (a type of roundworm) is found in Asia and Africa and causes a disease called Dracunculiasis. Dracunculiasis is not life-threatening, but it results in painful skin ulcers. Unlike other diseases caused by helminths, dracunculiasis is only transmitted through contaminated water (WHO, 1997). Table 1.1, from the World Health Organization shows waterborne pathogens and their significance in water supplies. Infectious dose information (as determined by the World Health Organization) for helminthes, as well as bacteria, viruses and protozoa, is also available in Table 1.1.

Table 1.1: Waterborne Pathogens and Their Significance in Water Supplies. Source: WHO 1993.

| Pathogen | Health significance | Persistence in water supplies ^a | Resistance to chlorine ^b | Relative infective dose ^c | Important animal source |
|-----------------------------------------------------------------------------|---------------------|--------------------------------------------|-------------------------------------|--------------------------------------|-------------------------|
| Bacteria | | | | | |
| <i>Campylobacter jejuni</i> , <i>C. coli</i> Pathogenic | High | Moderate | Low | Moderate | Yes |
| <i>Escherichia coli</i> - Pathogenic <i>Escherichia coli</i> - Toxigenic | High | Moderate | Low | High | Yes |
| <i>Salmonella typhi</i> | High | Moderate | Low | High ^d | No |
| Other <i>salmonellae</i> | High | Long | Low | High | Yes |
| <i>Shigella</i> spp. | High | Short | Low | Moderate | No |
| <i>Vibrio cholerae</i> | High | Short | Low | High | No |
| <i>Yersinia enterocolitica</i> | High | Long | Low | High(?) | Yes |
| <i>Pseudomonas aeruginosa</i> ^e | Moderate | May multiply | Moderate | High(?) | No |
| <i>Burkholderia pseudomallei</i> | | | | | |
| <i>Mycobacteria</i> | | | | | |
| <i>Legionella</i> | | | | | |
| Viruses | | | | | |
| Adenoviruses | High | ? | Moderate | Low | No |
| Enteroviruses | High | Long | Moderate | Low | No |
| Hepatitis A | High | ? | Moderate | Low | No |
| Hepatitis E | High | ? | ? | Low | No |
| Norwalk virus | High | ? | ? | Low | No |
| Rotavirus | High | ? | ? | Moderate | No(?) |
| Small round viruses | Moderate | ? | ? | Low(?) | No |
| Protozoa | | | | | |
| <i>Entamoeba histolytica</i> | High | Moderate | High | Low | No |
| <i>Giardia intestinalis</i> | High | Moderate | High | Low | Yes |
| <i>Cryptosporidium parvum</i> | High | Long | High | Low | Yes |
| <i>Acanthamoeba</i> | | | | | |
| <i>Toxoplasma</i> | | | | | |
| <i>Cyclospora</i> | | | | | |
| Helminths | | | | | |
| <i>Dracunculus medinensis</i> | High | Moderate | Moderate | Low | Yes |

? not known or uncertain

^a Detection period for infective stage in water at 20°C: short, up to 1 week; moderate, 1 week to 1 month; long, over 1 month

^b When the ineffective stage is freely suspended in water treated at conventional doses and contact times. Resistance moderate, agent may not be completely destroyed.

^c Dose required to cause infection in 50% of health adult volunteers; may be as little as one ineffective unit for some viruses.

^d From experiments with human volunteers

^e Main route of infections is by skin contact, but can infect immunosuppressed or cancer patients orally.

1.3 Project Goal

In order to reach the aforementioned goal of providing clean water for 1.1 billion people, 146 million people in Latin America and the Caribbean alone will need access to improved water sources¹. The goal of this thesis is to investigate the performance of the BioSand filter as a treatment method for unimproved water sources in the northwestern Dominican Republic, where 17% of the urban population and 30% of the rural population do not have access to an improved water source (WHO, 2000). This thesis shall combine bacterial, turbidity and flow rate data with survey information gathered in the Dominican Republic during January 2004 to create an overview of BioSand filter use on community-wide and household scales. It will also investigate the BioSand filter in a controlled lab setting at MIT to determine the efficacy of thermotolerant coliform removal from highly contaminated source water over the course of several weeks.

¹ The World Health Organization considers the following to be improved water sources: household connections, public standpipes, boreholes, protected dug wells, protected springs and rainwater collection. The following are not considered to be improved sources: unprotected wells, unprotected springs, bottled water, vendor-provided water, and tanker-truck provision of water (WHO, 2002).

2 Slow Sand Filtration

2.1 Slow Sand Filtration: Historical Background

Slow sand filtration has been used for water treatment for hundreds of years. The first known water treatment system to use elements of slow sand filtration was constructed in Lancashire, England as part of bleach works circa 1790 (Weber-Shirk and Dick, 1997). This filter's sole purpose was to improve the aesthetic quality of the water. The first slow sand filter used in a public water supply was constructed in 1804 in Paisley, Scotland. Water entering this filter flowed from a settling basin through a gravel filter, through a sand filter and into a holding chamber; thus incorporating both pretreatment and slow sand filtration (Baker, 1982). It was recognized in 1885 that slow sand filtration could remove bacteria. Particle and bacterial removal by straining was thought to be the main removal mechanism of the slow sand filter, with "bacterial action" proposed as a second explanation by T. Graham in 1850 (Weber-Shirk and Dick, 1997).

The first large scale demonstration of the effectiveness of slow sand filtration occurred during a cholera epidemic in Germany in 1892. Two cities, Altona and Hamburg drew their water from the Elbe River. Even though Altona's water intake was downstream from Hamburg's sewer outfalls, cholera cases occurred at a rate of 230 per 100,000 in Altona and 1,344 per 100,000 in Hamburg. The difference: Altona used slow sand filtration. The majority of cholera cases occurring in Altona could be traced to source waters in Hamburg (Logsdon, 2002).

The importance of the slow sand filter's *schmutzdecke*, roughly translated from German as "dirt blanket," began to be investigated around the turn of the century (the currently accepted definition of *schmutzdecke* refers to the thin layer of bacteria and soil particles located at the sand-water interface in a slow sand filter). It was recognized that the undeveloped filter cake (the sand bed of the filter not including the level of silt and biological organisms directly covering it) could not remove impurities as well as a filter containing a "gelatinous film." Early literature regarding the function of this layer is often quite confusing, as researchers developed their own definitions. The advent of other drinking water treatment system unit processes, such as, coagulation, rapid filtration and sedimentation technologies during the early 20th century

decreased interest in slow sand filtration. Slow sand filtration research slowed during the middle of the 20th century, with no significant research completed between 1915 and 1970.

During the early 1980s a resurgence of interest was stimulated by increasingly stringent EPA surface water treatment guidelines (Weber-Shirk and Dick, 1999), as well as the discovery that slow sand filtration could be a viable means of removing *Giardia lamblia*, an intestinal parasite, from water sources (Logsdon et al. 2002). A freshly packed filter (not biologically mature) can remove 99% of *Giardia* cysts. The 1985 Bellamy et al. study showed that only 26 cysts/L passed all the way through a slow sand filter with an influent *Giardia* concentration of 2,770 cysts/L (hydraulic loading rate = 0.47 m³/m²/hr). Rapid filtration (hydraulic loading rate = 14 m³/m²/hr) resulted in less than 50% removal of *Giardia* cysts, showing that hydraulic loading rate is a critical variable influencing water quality in slow sand filters (Bellamy et al. 1985). Current interest in slow sand filtration focuses on pretreatment of water sources as well as applications to water treatment in small communities and in developing countries.

2.2 Basic Design Elements of Slow Sand Filters

Though designs and scale may vary and pretreatment options abound, there are several elements common to community-scale slow sand filtration systems. There is no consensus on filter design standards, though several sets of conditions for good filter performance have been developed. Three commonly followed sets of design criteria are the Ten States Standards, those developed by Huisman and Wood, and those developed by Visscher et al. The Ten States Standards were developed for use in designing community-scale slow sand filtration plants in the United States. Those developed by Huisman and Wood are mainly based on the analyses of slow sand filtration in Europe before 1974. Guidelines developed by Visscher et al. are intended for use in developing nations (Pyper and Logsdon, 1991). Selected criteria from all three sets of standards are shown in Table 2.1.

Table 2.1: Selected Criteria for Slow Sand Filter Design. Adapted from Pyper and Logsdon 1991.

| Design Criteria | Ten States Standards | Huisman and Wood | Visscher et al. |
|------------------------------------------------------|----------------------|------------------|-----------------|
| Filtration Rate (m ³ /m ² /hr) | 0.08-0.24 | 0.1-0.4 | 0.1-0.2 |
| Initial Depth of Sand(m) | 0.8 | 1,2 | 0.8-0.9 |
| Effective Sand Size (mm) | 0.3-0.45 | 0.15-0.35 | 0.15-0.3 |
| Depth of Support Media Including Underdrains (m) | 0.4-0.6 | Not stated | 0.3-0.5 |
| Depth of Supernatant Water (m) | ≥0.9 | 1-1.5 | 1 |

Filtration Rate: The filtration rate (also known as the hydraulic loading rate), expressed in volume per unit area per time, is the rate at which water passes through the filter bed (Barrett et al., 1991). The filtration rate in most slow sand filtration plants is typically between 0.1 and 0.3 m³/m²/hr (Logsdon and Pyper, 1991). Flow rates in roughing filters (a form of pretreatment) vary from 0.3 to 1.5 m³/m²/hr (Hendricks, 1991). The volume flow rate is defined as the rate of flow through an orifice, and is expressed in L/s or ft³/s (Barrett et al., 1991). A volume flow rate can be obtained by multiplying the hydraulic loading rate by the area of the sand bed.

Higher hydraulic loading rates cause an increase in the pressure of water in the head space, in turn causing a faster filtration rate. Though differences in filtered water quality from slow sand filters with loading rates between 0.04 m³/m²/hr and 0.4 m³/m²/hr were found to be negligible, loading rates above this range show substantial dependence on hydraulic loading rate (Hendricks and Bellamy 1991).

Filter Bed: The term “filter bed” refers to the portion of a filter containing sand. Sand selection is a key factor in filter design, as physical straining is possibly the main mechanism of particle removal in filter beds (Weber-Shirk et al., 1997). High efficiency slow sand filtration occurs in filter beds containing sand of a uniform diameter between 0.1 and 0.3 millimeters², though some slow sand filters use varying grades of sand and two grades of gravel (Campos et al., 2002). Davnor’s commercial BioSand filter, for example, uses three grades of sand in the sand bed,

² 0.1 mm corresponds to ASTM Mesh #170, Tyler Mesh #170, and BS Mesh #170, 0.3 mm corresponds to ASTM Mesh #48, Tyler Mesh #50, and BS Mesh #52

while the CAWST BioSand filter (patterned on the Davnor BioSand filter) uses only one grade of sand (referred to as medium sand). A mature filter bed contains a variety of bacterial, protozoa and algae species, some of which aid in the removal of turbidity-causing particles and microorganisms. The schmutzdecke forms on top of the filter bed, providing a very efficient sieve for both particle and microbial removal. The majority of removal takes place in the schmutzdecke and top two centimeters of the filter bed via transport and attachment to the filter medium. Figure 2.1 is a schematic of a typical slow sand filter with key components (including the filter bed) labeled.

The size of the sand selected for the filter bed is directly linked to removal rates. A study completed by Bellamy et al. in 1985 compared bacterial removal efficiencies in slow sand filters with three different sand sizes: 0.62³, 0.28⁴ and 0.13⁵ mm in diameter. Total coliform removal efficiencies were 96%, 98.6% and 99.4%, respectively (Bellamy et al., 1985). Larger sand particles and gravels outside the range of acceptable diameters (0.15 mm to 0.35 mm) are reserved for use in roughing filters and under drains, where the more efficient removal of small-grain media is not necessary.

An increased bed filter depth provides a higher quality effluent, provided that the filter bed depth is less than 0.5 meters (Bellamy et al., 1985). Increasing filter depth above 0.5 meters does not significantly improve effluent quality, though traditional slow sand filter systems are designed to have a bed depth of one meter (Logsdon et al., 2002).

Gravel Bed: After water travels through the filter bed, it flows through the gravel bed (see Figure 2.1). Some slow sand filters contain more than one grade of gravel, which is graded from smallest diameter (found closest to the filter bed) to largest diameter (found closest to the filter drain). This gradient of gravel serves to keep sand from the filter bed sand from leaving with the treated water or clogging the filter effluent.

³ 0.62 mm corresponds to ASTM Mesh #28 Tyler Mesh #30, and BS Mesh #25

⁴ 0.28 ASTM Mesh #48, Tyler Mesh #50, and BS Mesh #52

⁵ 0.13 mm corresponds to ASTM Mesh #115, Tyler Mesh #120, and BS Mesh #120

Filter Underdrain: The filter underdrain can consist of perforated plastic pipes, stacked bricks or very porous concrete. Water flows from this area to the outflow. The filter underdrain is mainly a mechanism of transporting water out of the filter (see Figure 2.1).

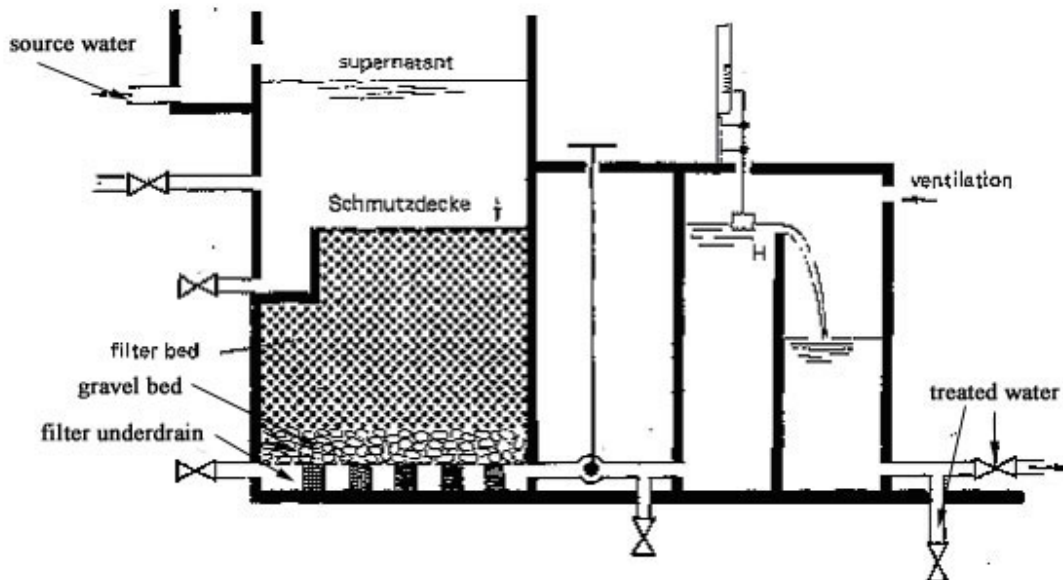

Figure 2.1: Typical Slow Sand Filter. Adapted From: IRC/WHO, 1978 (as seen at <http://ces.iisc.ernet.in/energy/water/paper/drinkingwater/simplemethods/filtration.html>)

2.3 Mechanisms of Contaminant Removal in Slow Sand Filters

Simple straining is the main removal mechanism in slow sand filtration. Contaminant particles larger than the pores between sand particles become trapped at the water-filter bed interface and are thus removed from the water, forming a filter cake. As finer particles become trapped in the filter cake, pore spaces in the filter cake become smaller and particle removal increases. While particle and contaminant removal increases, filtration rate decreases (Weber-Shirk et al., 1997). A severely decreased filter rate signals the need for filter maintenance.

In addition to mechanical straining, several biological mechanisms are thought to be at work in slow sand filters. The importance of a mature biological community's presence in a slow sand filter bed has been demonstrated, though there is a dearth of conclusive evidence on the subject (Haarhoff and Cleasby, 1991). One study, completed by Bellamy et al. in 1987, showed that a sand filter devoid of biological activity induced by high level of chlorination added during the experiment removed bacteria at a rate of 60%, in comparison with the 98% rate of removal observed in the control filter. Some of our research in the Dominican Republic on household

BioSand filters receiving intermittently chlorinated water from a municipal supply points to the same conclusion (see Section 10.3). The biological contaminants that were not removed are assumed to be smaller than the typical 2 μm pore spaces between sand particles (Bellamy et al., 1987).

The effectiveness of a slow sand filter depends on several bacterially-mediated processes. These processes include bacterivory and predation, addition of bacterial and biological byproducts such as seston, and attachment to bacterial biofilms. Bacterivory, or predation by bacterial populations found in the filter bed and *schmutzdecke*, was suspected to be a significant cause of bacterial removal from slow sand filters. Monroe Weber-Shirk and Richard Dick of the School of Civil and Environmental Engineering at Cornell University explored predation by a chrysophyte (a 3- μm diameter protozoan) isolated from the effluent of a slow sand filter receiving Cayuga Lake water. This chrysophyte was added to a slow sand filter device containing glass beads with a uniform diameter of 0.17 mm. Both the control filter and the filter receiving the chrysophyte were dosed with *E. coli* and *P. putida* bacteria. After one day, the filter with the chrysophyte showed 99.7% removal of *E. coli*, while the control was only able to remove 10%. Two days later, both filters were removing *E. coli* at a rate of 99%, demonstrating that the addition of the chrysophyte can expedite filter ripening (Weber-Shirk and Dick, 1997).

This study also yielded evidence that bacteria and possibly bacteria-sized particles can be removed by adding a chrysophyte, though chrysophyte populations can only be elevated to the level needed for significant predation by increasing the bacterial concentration of influent water. It should be noted that bacterivory is only a significant means of removing bacteria smaller than 2- μm (Weber-Shirk and Dick, 1997). *E. coli*, for example, has a typical size of 1- μm (1997).

A Weber-Shirk experiment taking place in 2002 examined the effects of adding an acid-soluble seston extract from Cayuga Lake to water before slow sand filtration. Seston is a combination of particulate matter such as plankton, organic detritus and inorganic particles such as silt found suspended in water. Experimental filters (of the same experimental setup as that used in the chrysophyte experiment) were each given a steady stream of a different concentration of seston extract, while a control filter was given none. The extract was found to change the surface

properties of the filter media. Results from the experiment showed that even the addition of small amounts of the seston extract resulted in significant *E. coli* removal (better than 3-log removal in a filter receiving less than 1.2 g/m² of extract). Addition of the extract, like the addition of the chrysophyte can increase the rate of filter ripening (Weber-Shirk 2002).

Other proposed biological removal mechanisms include attachment to algae and inactivation of bacteria by phages and toxins. It has also been suggested that bacteria entering the filter via source water produce extracellular polymers and attach to media in the filter, though this is considered to make a very insignificant contribution to removal (Logsdon 2002). Many have hypothesized that bacteria and particles are removed from source water via attachment to sticky biofilms, though this removal has not been directly measured (Weber-Shirk et al., 1997). Other biological processes with possible effects on filtered water quality may include:

- Death of influent bacteria
- Metabolic breakdown of organic carbon substrates by bacteria existing in the filter column. The bacterial population in a filter appears to be able to metabolize incoming bacteria effectively until a threshold concentration is reached.
- Bactericidal algae effects
- Increased stickiness of sand surface

2.4 Additional Variables Influencing Filter Performance

2.4.1 Water Temperature

Slow sand filters are less effective at lower temperatures. A decrease in temperature from 17°C to 5°C showed that total coliform removal rates dropped to 87%, compared to a removal rate of 97% in the control filter remaining at 17°C, and that effluent plate counts were 100 times higher at 2°C than at 17°C (Bellamy et al. 1985). This data was obtained from a study comparing a series of parallel influents from the same source at different temperatures. A 1956 study comparing the effects of seasonal water temperature changes on bacterial removal efficiencies showed removal efficiencies of 41% and 88% in February, compared to 99% removal efficiency during the remainder of the year (Burman, 1956).

Low temperatures can cause anaerobic conditions to occur in the filter bed, resulting in speciation changes in the biological community in the filter, though this is not likely to occur at most water temperatures typical of the tropical and subtropical climates of many developing countries. High temperatures have been shown to decrease settling times by decreasing the viscosity of the water, allowing particles to settle faster (Schulz and Okun, 1984).

2.4.2 Influent Water Composition

Increasing influent bacterial concentrations cause both increased removal efficiency and increased filtered water concentrations (Bellamy et al., 1985). Bellamy found that filtered water bacterial plate counts are independent of influent concentrations in the range from 100 CFU/100 ml to 100,000 CFU/100 ml, suggesting that the bacterial population of the sand bed is able to consume influent bacteria until its concentration reaches a threshold concentration (Bellamy et al., 1985). It is important to note that 100 CFU/100 ml to 100,000 CFU/100 ml is quite a large range, and the two aforementioned conclusions seem somewhat contradictory.

Water supplied to slow sand filters should be of the highest quality possible. Its turbidity should ideally be less than 5 NTU (Cleasby, 1991), and the water should be low in bacteria, color, trihalomethane precursors, toxic substances, dissolved heavy metals and algae (Logsdon et al., 2002). Water high in turbidity will clog the top layer, preventing filtration and shortening the life of the filter. Slow sand filters have not been proven to have the capacity to remove trihalomethane precursors and other toxins (Pyper and Logsdon, 1991).

3 The BioSand Filter

3.1 Household-Scale Slow Sand Filtration

Unlike the constantly-operated slow sand filters used in water treatment plants, household-scale slow sand filtration involves intermittent operation of a slow sand filter. Household-scale slow sand filtration places individual families in control of filtering their water, avoiding the pitfalls often associated with implementing centralized water treatment programs. Persons using household-scale treatment methods do not depend on an outside source for maintenance and education.

3.2 BioSand Filter History

The BioSand filter was developed in the early 1990s by Dr. David Manz while working as a civil engineer at the University of Calgary. Dr. Manz's BioSand filter is a low cost (about \$35 US) household-scale slow sand filter of a specific patented design described below and in Section 3.2. BioSand filters were first used for water treatment in 1993, when one was installed in each home in Valler de Menier, Nicaragua. The efficacy of the filter was clearly demonstrated in 1996, when a doctor working for the NGO "Samaritan's Purse" reported that no one in Valler de Menier contracted cholera while many people in other portions of the country died from the disease. Recognizing the BioSand's potential for success as a simple and sustainable household water treatment technology, Samaritan's Purse has since installed 26,000 BioSand filters worldwide. At the end of 2001, various church groups and NGOs, including Samaritan's Purse, had installed more than 50,000 BioSand filters in more than 40 countries worldwide, including Haiti, the Dominican Republic, Nepal, and Nicaragua (CAWST, 2003).

The BioSand filter was introduced to the Dominican Republic in 2000, when Dr. Jan Tollefson from the Canadian NGO "Add Your Light" invited Dr. Manz to conduct a workshop to teach 14 Dominicans to make the filter. Of the 14 original technicians, four continue to produce the filter. These four technicians, José Rivas, Juan Bencosme, Edgar Rodriguez and José Esteves, have formed AFAFIL (the Association of BioSand Filter Makers) and have received financial support from "Add Your Light" to build BioSand filter construction shops. They are currently selling filters and working on filter projects with international support from groups including the Canadian Embassy and Rotary Clubs in the United States and Canada (Tollefson, undated).

The Masters of Engineering program in MIT's Department of Civil and Environmental Engineering has been studying the BioSand filter since 2000, and several Masters of Engineering theses have been written on the subject. Nathaniel Paynter's 2001 thesis evaluated the water needs and supplies, sanitation, and contaminated water problems related to a Biosand filter pilot program in Nepal (Paynter, 2001). Tse-Lue Lee's 2001 thesis focused on coliform and turbidity removal efficiencies of the same BioSand filter pilot program (Lee, 2001). Heather Lukacs' 2002 thesis continued evaluation of the BioSand filters in Nepal (Lukacs, 2002). Finally Melanie Pincus' 2003 thesis continued the work of Paynter, Lee and Lukacs, as well as evaluating a BioSand-based filter pitcher she developed (Pincus, 2003).

3.3 Advantages and Disadvantages of Household-Scale Slow Sand Filtration

The BioSand filter has many advantages that make it attractive to potential users. The BioSand filter is constructed from materials such as sand and concrete, which are available in many areas. It does not contain materials that break easily or must be replaced. The lifetime of the BioSand filter is indefinite, assuming the user cares for it appropriately. No chemicals need to be added to the filter, which saves money and does not result in possible negative health effects. The process of slow sand filtration removes parasites, bacteria and certain toxins. The filter is simple to operate and has a simple maintenance routine. Finally, the high flow rate of the filter allows the filter to easily treat enough water for one or more families each day.

Disadvantages of BioSand filter are common to the slow-sand filtration method of water treatment in general. The filter must be used on a regular basis to maintain removal efficiency. Slow sand filtration cannot remove color or dissolved compounds. The BioSand filter cannot be easily moved once it is put in place because it is extremely heavy. Moreover, moving the filter may disrupt the carefully leveled sand and gravel beds. As with all slow sand filters, the BioSand will clog and require more frequent maintenance if source water is highly turbid. Lastly, slow sand filter users must remember to store enough clean water for several days prior to cleaning the BioSand filter.

3.4 BioSand Design

The BioSand filter contains aspects common to a slow sand filter. It contains a filter bed consisting of medium sand above a layer of small gravel. Below the small gravel is another layer of larger gravel. The lower portion of the effluent pipe is located in this layer of gravel (see Figure 3.1). The BioSand filter has a lid with which to cover the filter when not in use. The BioSand filter also contains a diffuser plate. This plate is a sheet of plastic with holes drilled in a grid pattern. The diffuser plate spreads water poured into the filter evenly over the surface of the sand, minimizing disturbance of the *schmutzdecke*.

The sand used in the filter bed of a BioSand filter is between 0.45 mm⁶ and 1.19 mm⁷ in diameter. As in large-scale slow sand filters, the presence of a *schmutzdecke* is thought to be vital to the performance of the BioSand. The main removal mechanisms found in other slow sand filters (bacterivory, death of influent bacteria, adsorption to sand and mechanical straining) are similarly present in the BioSand filter (Tollefson, undated). The recommended filter flow rate of a BioSand filter, however, is faster than that of a typical slow sand filter (BioSand filter flow rate: 60 L/hr).

⁶ 0.45 mm corresponds to Tyler Mesh #32, ASTM Mesh #35, and BS Mesh #30

⁷ 1.19 mm corresponds to Tyler Mesh #14, ASTM Mesh #16, and BS Mesh #14

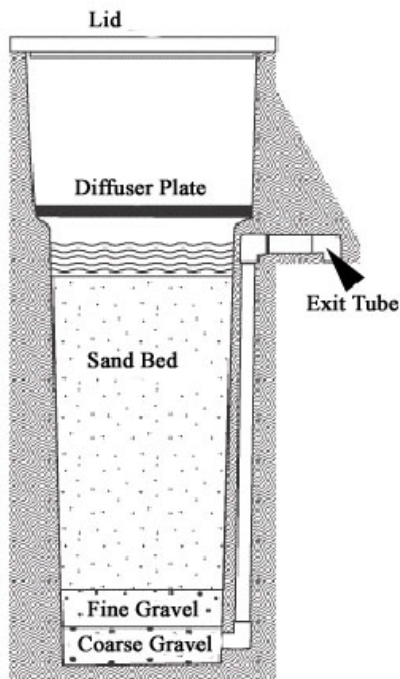

Figure 3.1: BioSand Filter Schematic. Image Source: www.friendswhocare.ca/FWCpage2A.htm

3.5 BioSand Filter Construction and Installation

3.5.1 Filter Construction

The first step in construction of the BioSand filter is preparation of the outflow pipe.

Construction of the outlet pipe requires one PVC T-joint (12 mm in diameter, threaded on both sides), two 90° PVC elbow joints (12 mm in diameter, threaded on both sides), one 68-cm section of 12 mm diameter PVC pipe, one tube of PVC adhesive, and one male PVC pipe cap (IDRC Module 5, 1998). First, the 68 cm section of 12 mm diameter PVC pipe is cut into three pieces (57 cm, 7.5 cm and 4 cm). Next, one arm of the T-joint is cut away. The cut T-joint is then glued to one end of the 57 cm section of pipe. The two elbows are glued to the ends of the 7.5 cm section of pipe, creating a ‘U’ shape. This ‘U’ shape is glued to the free end of the 57 cm section of pipe. Finally, the 4 cm section of pipe should be placed (not glued) in the free end of the ‘U’ shape. The completed outflow pipe is shown in Figure 3.1.

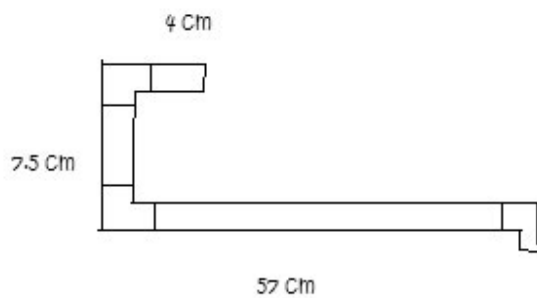

Figure 3.2: PVC Pipe Assembly.

After constructing the pipe assembly, the filter is ready to be constructed. This process requires a BioSand filter mold, 45 kg of Portland cement, 51 kg of river sand, and 70 kg of 5 mm gravel, a rubber hammer, oil, a paintbrush, a construction rod and a shovel (IDRC Module 5, 1998). First, the mold must be thoroughly greased with oil. If the entire inside of the mold is not greased, the concrete will stick to the mold and the filter will be impossible to remove. Once the mold has been greased, the pipe assembly should be installed in the outer portion of the mold as shown in Figure 3.2. Next, the inner and outer portions of the mold are bolted together. Water is added to a concrete mixed in a ration of 1(Portland cement):2 (river sand): 3 (5mm gravel) until the mixture has a porridge-like consistency. One-third of the mixture is poured into the mold, and a construction rod is moved in and out of the mixture to remove air bubbles and force the concrete into any empty spaces. A rubber hammer is pounded against the sides of the mold to remove any remaining air bubbles that may weaken the filter or decrease the aesthetic quality of the finished project. This process is repeated twice more with the remainder of the concrete. When the mold is full, the top is leveled with a spade or trowel. The concrete is left to cure for 12 hours in a dry climate or 24 hours in a more humid climate (Tollefson, undated). If the filter is left to cure for longer than 24 hours, it will be difficult to remove from the mold.

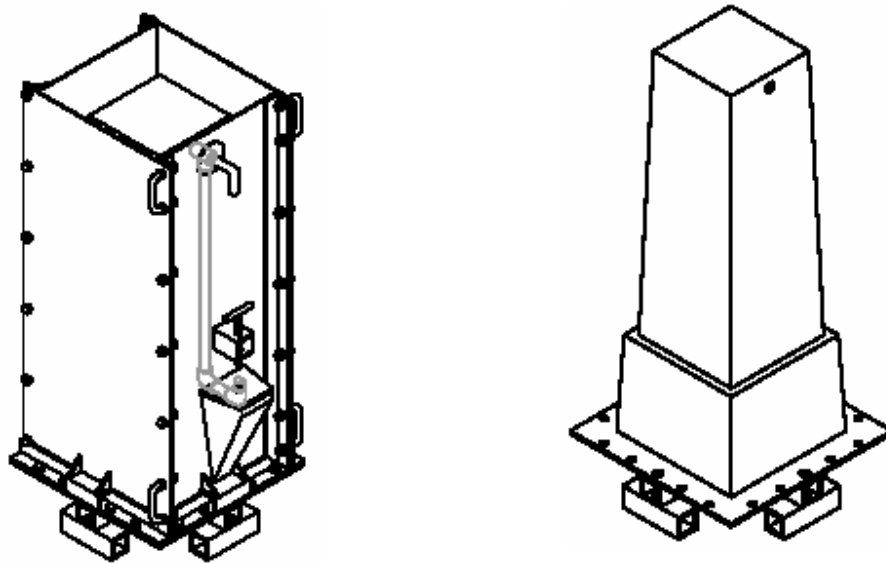

Figure 3.3: BioSand filter molds. The outer mold (left) shows the placement of the pipe assembly in gray, and the inner mold has a hole where the pipe assembly should be connected. Source: DAVNOR, 1998.

Wh
en

the filter has cured, it should be removed from the mold. The International Development Research Center (IDRC) recommends that the filter be kept wet and out of direct sunlight for the next two or three days to avoid cracking (Dr. Jan Tollefson recommends seven to nine days). The mold should be cleaned for its next use. After the filter has cured, a piece of solid, flat or HDPE other appropriate plastic that fits snugly on the interior ledge of the filter should be selected for the diffuser plate. One-eighth of an inch holes should be drilled approximately two inches apart throughout the plate. Figure 3.3 shows a plastic diffuser plate in a BioSand filter.



Figure 3.4: A diffuser plate inside a BioSand Filter in the Dominican Republic. Source: Heather Lukacs, 2004.

3.5.2 Filter Installation

Before BioSand filter gravel and sand installation, a level site should be selected in the user's kitchen or other appropriate location because once the filter is in place, it should not be moved. After placing the filter, two to three inches of water is added to the empty concrete shell. There is should always be water in the filter when adding the gravel underdrain and sand filter media. Next, 7.5 cm of large gravel⁸ is added to the filter and leveled by hand. The diffuser plate is put in place and water is added until it reaches a level approximately 10 cm above the under drain gravel. The diffuser plate ensures that the addition of water will not disturb the leveled gravel. After the diffuser plate is removed, 4.5 cm of coarse sand⁹ is added and leveled (IDRC Module 5, 1998). The diffuser plate is replaced and 10 inches of water is added to the filter. Next, half of the fine sand¹⁰ is poured into the filter and leveled. The process of adding water and sand is repeated until there are only three inches between the surface of the sand and the diffuser plate (CAWST instructions recommend four inches of space, but variation in mold size makes three

⁸ The IDRC recommends gravel between five and six millimeters (five millimeters roughly corresponds to Tyler Mesh #4, ASTM Mesh #4, BS Mesh #3.5)

⁹ Coarse sand should be between 1mm and 2mm in diameter. One millimeter corresponds to Tyler Mesh #16, ASTM Mesh #18, and BS Mesh #16; two millimeters corresponds to Tyler Mesh #9, ASTM Mesh #10, and BS Mesh #8.

¹⁰ Fine sand should be under 1 mm in diameter.

inches of space appropriate for filters constructed in the Dominican Republic). The diffuser plate is replaced, and the filter is filled with water. The flow rate at the effluent tube is measured using the flow rate procedure described in Chapter 6. The flow rate is a critical parameter used to determine the proper installation and functioning of a BioSand filter. A newly installed BioSand Filter should have a flow rate between 0.2 L/min (12 L/hr) and 1 L/min (60 L/hr). Flow rates much greater than 1 L/min (60 L/hr) signal the likelihood of less than optimal bacterial removal.

In the Dominican Republic, the last step of BioSand filter installation is effluent tube and gravel sanitization (the IDRC does not have a recommended sanitization procedure). A piece of PVC tube is attached to the effluent pipe and two liters of a solution containing sodium hypochlorite is poured into the tube and left to sit for 10 to 15 minutes. The tube is removed, and several buckets of water are poured through the filter (Tollefson, undated).

3.6 Maintenance and Cleaning Procedures

BioSand filter maintenance is explained to the user while the effluent tube and the gravel are being sanitized. Users are instructed how to use and maintain the filter. Water should be poured into the filter's head space slowly with the diffuser plate in place, and separate buckets should be used for pouring source water into the filter and collecting filtered water. Nothing should be connected to the outflow pipe of the filter, including taps and tubing. When not in use, the lid should be kept on the BioSand filter. Adults should tell children to keep their fingers away from the outflow pipe, and animals should be kept away from the filter. The treated water spout should be wiped with a clean cloth and chlorine weekly.

When the BioSand filter's flow rate slows from 1 L/min (60 L/hr) to close to 0.3 L/min (18 L/hr), it is necessary to clean the sand. After setting aside enough clean water for two days, the user should remove the diffuser plate from the filter. The user should swirl the water in the head space with two fingers until turbidity is visible in the water. The dirty water (but not the sand) should be removed with a cup. All of the water above the sand should be removed in this manner. After the water has been removed, more water should be added and the dirt removal process is repeated until the water above the sand is clear. Finally, the sand is leveled by hand

and the diffuser plate is replaced. Water is poured into the filter until the water level of the standing water layer is approximately 5 cm above the filter bed. Filtration may resume in two days (INDENOR).

4 Pretreatment Options for Slow Sand Filtration

The efficiency of slow sand filtration can be increased by pairing filtration with one or more pretreatment processes. Pretreatment is necessary in water sources with turbidities above 50 NTU, which can occur in contaminated surface waters and during monsoons and periods of flooding (Schulz and Okun 1984). Exposing a sand filter to high turbidity water for extended periods of time will quickly clog the filter, slowing the flow rate to a trickle.

Many pretreatment options exist, some more feasible for the material, social and economic climates of a developing country than others. Unlike rapid filtration and other water purification methods, pretreatment methods designed for slow sand filtration are not generally chemically dependent, making them more likely to be accepted in different cultural environments, as some cultures consider “natural” water to be more “clean” than water purified by chlorine or by processes involving chemical flocculation agents. Three of the pretreatment options discussed (shading, sedimentation and storage, cloth filtration, and use of roughing filters) are more appropriate than the other options described for use with the BioSand filter. They do not involve the addition of chemicals and are simple and easy to use. The remaining two pretreatment methods (prechlorination and ozonation) are suitable for community-scale slow sand filtration plants rather than household-scale slow sand filtration.

4.1 Shading

Shading is possibly one of the simplest forms of pretreatment. It entails covering the filtration system, or placing it in a shaded area. Shading diminishes the primary productivity of the filter, decreasing the probability of an algal bloom. It decreases windblown contamination and keeps bird droppings and bugs out of the water supply. Some believe that shading may reduce the activity in the *schmutzdecke*, but no differences in filtrate quality have been observed (Pyper and Logsdon 1991).

4.2 Sedimentation and Storage

The process of sedimentation involves collecting water and letting it sit undisturbed while large particles settle out of the water column. This process is recommended for waters having turbidities between 20 and 100 NTU (Huisman and Wood 1974). Short term sedimentation (less than 12 hours) can be very effective in water sources with a high suspended solids load, which may occur during flood conditions. Storage (or long term sedimentation) can be more effective than short term sedimentation, but is often accompanied by the development of algal blooms. Storage is the best pretreatment option for extremely turbid water (Schulz and Okun 1984). Sedimentation is most effective when followed by use of a roughing filter or other type of prefiltration. Sedimentation and storage can easily be combined with shading to pretreat the water and prevent further contamination.

4.3 Cloth Filtration

Bangladeshi women have developed a unique approach to pretreatment incorporating use of the traditional sari. A 2002 epidemiological study (Colwell et al. 2003) demonstrated that folding an old cotton sari four to eight times and placing it over a *kalash* (a Bangladeshi water collection vessel) is equivalent to using a 20 μm filter (one layer of a sari is equivalent to a 100 μm filter), which can remove all zooplankton, most phytoplankton and *Vibrio cholerae* (a cholera causing bacterium) attached to plankton. A 38% reduction in the occurrence of cholera was seen among filter users, with a cholera rate 48% of that of the control group (which used nylon filters), showing that sari filtration can be considered an effective means of filtration. It should be noted that cholera is a dose-dependent sickness, and filtration does not mean that all *V. cholerae* is removed from the water (Colwell et al. 2003). The fact that new saris do not remove microorganisms nearly as effectively as old saris (the pore size of a used sari is much smaller due to wear, which causes softening and loosening of fibers –see Figure 3.1) makes this technique especially plausible for developing countries, and warrants further research of different types of materials. The use of old saris is also culturally acceptable in Bangladesh, whereas the use of chemicals is less acceptable.

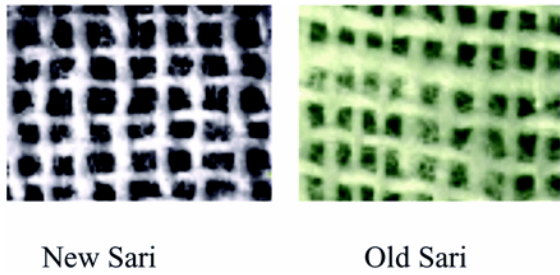

Figure 4.1: Pore size differences in new and old cotton sari fabric. Source: PNAS 100(3): p. 1052.

4.4 Roughing Filters

There are two main types of roughing filters: upflow and downflow (both of which can be horizontal or vertical). Upflow filters have *E. coli* removal efficiencies ranging from 70 to 90%, and can remove 52% of turbidity in water of good quality (Schulz and Okun 1984).

Unfortunately, upflow filters require backwashing, which is probably not a feasible option for the BioSand filter and other household-scale filters such as the Table Filter used in Peru.

Horizontal roughing filters offer the option of unlimited length, which allows untreated water to spend more time in the system. Due to the large amount of space often occupied by horizontal roughing filters, they are often better suited for use in plants than household systems.

Roughing filters, both horizontal and vertical, have a great capacity for sediment storage. The diameter of sand and gravel used in these filters is larger than 2 mm¹¹ ensuring a greater load capacity than the filter bed of a slow sand filter. Due to increased pore size, rates of infiltration can be much greater in roughing filters (up to 8 m/hr in vertical and horizontal filters), making the roughing filter an option that will not slow down the overall process of filtration the way sedimentation and storage might. Though roughing filter flow rates can be quite high and still be effective, most roughing filters operate at filtration rates between 0.3 and 1.5 m³/m²/hr (Logsdon 2002). Longer residence time in a roughing filter equates to better removal efficiencies.

Removal efficiencies of both sediment and algae depend on the hydraulic loading rate of the roughing filter.

¹¹ 2 mm corresponds to Tyler Mesh #8, ASTM-E11 Mesh #10, and BS Mesh #8

Roughing filters can be constructed in a variety of ways. Many systems use a form of media gradation, forcing the water to flow through areas of smaller and smaller pore size. This can be accomplished by using gravel and sand of different sizes and layering them or separating them in separate sections of the roughing filter. Cleaning a roughing filter can be as simple as backwashing or removing and rinsing the gravel.

Sand and gravel are not the only options for roughing filter media. Slow sand filtration users in Thailand have been using shredded coconut fibers in roughing filter construction. These fibers can be obtained at low cost or free. Filters are scraped from the coconut and dried. A roughing filter consisting of coconut fibers is 60 to 80 cm thick and can last three to four months. Though no numerical data was available, this system is said to be effective (Schulz and Okun 1984).

4.5 Prechlorination

Chlorine is both an algaecide and a bactericide and can lead to a longer filter life. Chlorine works by oxidizing material, making no distinction between living and inert materials (Bellamy et al. 1985). Large doses of chlorine, however, can lead to bad odor and color, differences in water taste, production of trihalomethanes, and production of ammonia and organic nitrogen. The biological community of the filter is destroyed, leaving filter operators to rely on physical processes and chlorination alone. The detrimental effects of prechlorination in slow sand filtration (specifically household-scale water treatment systems like the BioSand filter) and costs associated with large scale chlorine production make it inappropriate for most developing countries. Post-filtration chlorination is a more viable option.

4.6 Ozonation

Adding ozone to influent water increases flocculation and breaks macromolecules into biodegradable pieces, and can increase filter life (van der Hoek et al. 2000). If added at the beginning of a filter's life, ozone can control algal growth. If ozone is added after algae have already had a chance to establish themselves in the filter, it will have no effect on algal speciation. Ozonation increases the rate of organic carbon removal and increases the removal potential of trihalomethanes and trihalomethane precursors (Logsdon 2002). The biological and chemical removal efficiencies increase at temperatures below 8°C, which may counteract the

reduction in filtration efficiency that occurs at lower temperature. Detrimental effects of ozonation include increased head loss at high ozone concentrations and a reduction of algal diversity. Ozonation is impractical for use with the BioSand filter. It requires production of ozone, which is an expensive and technically intense process. The BioSand filter is designed to be a simple-to-use method for household-scale water treatment, and the process of ozonation is not.

5 Site Description

Field work during IAP 2004 took place in the northwestern sector of the Dominican Republic. Time was split between three cities and the surrounding rural areas: Mao (January 5 through January 12), Dajabon (January 12 through January 19), and Puerto Plata (January 19 through January 23), which are marked in Figure 5.1.



Figure 5.1: Map of the Dominican Republic. January 2004 Sites Boxed. Source: National Geographic Society.

5.1 The Dominican Republic

The Dominican Republic occupies the eastern two thirds of the island of Hispaniola, an island approximately the size of Scotland (Bell 1981). The country of Haiti (from which the Dominican Republic gained its independence in 1844) occupies the western third of the island. The Dominican Republic has a population of 8,715,602, and the official language is Spanish (CIA Fact Book, 2003). Per capita income is approximately \$6,300 USD, and 25% of the population falls below the poverty line.

5.2 Mao, Hundidera and Los Martinez

Mao is the both the capital and the largest city of the Valaverde Province, which is surrounded by Santiago, Puerto Plata, Monte Cristi and Santiago Rodriguez Provinces. While in Mao, filters were tested in the city itself and in two nearby rural towns, Hundidera and Los Martinez.

Hundidera is a rural community close to Mao. The majority of the citizens of Hundidera rely on tobacco farming for their income. Hundidera's citizens buy their water from trucks, use rainwater, and obtain water from Rio Mao. Los Martinez is a community similar to Hundidera. The rural towns in the Dominican Republic, including Hundidera and Los Martinez, tend to have latrines instead of flush toilets. Homes in the city and in the country both use *tinacos*, or large storage tanks found on the roof. These gravity-driven roof tanks allow the water to flow from the *tinaco*, through a pipe and into a tap, usually in the kitchen. Analysis of all samples from Los Martinez, Hundidera and Mao took place at INDENOR, a Dominican NGO located right outside the center of Mao. The team visited a total of 24 houses of varying income levels during this portion of the field study.



Figure 5.2: Typical scene in Hundidera, Dominican Republic.

5.3 Dajabon, Cajuco and Las Matas de Santa Cruz

Dajabon is a centuries-old city on the border of Haiti and the Dominican Republic. It is the capital of the Dajabon Province and home to a large open market, where thousands of Haitians, Dominicans and tourists come to shop and interact. Though the group spent more time in

Dajabon than Mao, fewer samples were taken. Team members visited a Peace Corps village and learned about a rural solar-powered lighting project sponsored by the Canadian NGO “Add Your Light”, as well as meeting with a Peace Corps volunteer to learn about his experience with the BioSand filter. The team also attended a workshop on the construction and installation of BioSand filters put on by the founder of Add Your Light, Dr. Jan Tollefson. While in Dajabon, the team tested BioSand filters in the smaller towns of Las Matas de Santa Cruz and Cajuco. All analysis took place in the team’s hotel.



Figure 5.3: Crossing the Border between the Dominican Republic and Haiti.

5.4 Playa Oeste, Los Dominguez and Javillar de Costambar

Puerto Plata is a relatively large city on the northern coast of the Dominican Republic, and contains one of the two major airports in the country. It is a place of great contrast, filled with German and American tourists, foreign business owners and Dominicans. There is a large income gap between the classes, with huge houses and tourist hotels located within blocks of *barrios* with houses made of plywood and cardboard. Puerto Plata was once a desirable tourist location, but is currently fighting a poor economy and competing with nearby Sosua and Cabarete for tourists.

Playa Oeste is a *barrio* on the western edge of Puerto Plata, directly overlooking the portion of the port at which huge container ships enter the city. The sea water is full of garbage from the container ships and the people that live nearby. The streets are extremely close together and houses are crowded together. Tap water is available during certain hours of the day throughout the various barrios of Puerto Plata. This tap water comes to the barrios from an aqueduct.



Figure 5.4: Typical Home in the hills near Puerto Plata.

Los Dominguez is a community located in the foothills of the mountains behind Puerto Plata. All of the homes visited in this community had concrete floors, electricity and plumbing, and the filters were sold to families with more money due to the belief that they would take better care of them. A Health Board representative comes to the community a few times a year to talk about the importance of clean water and other issues. All laboratory analysis took place in a private residence in Puerto Plata.

5.5 User Filter Cost

Filters users in Hundidera paid 600 pesos (US \$26)¹², with the remaining 600 (US \$26) pesos subsidized by the Dominican NGO INDENOR. Filters users in Entrada de Mao and Los Martinez also paid half of the filter cost (half of the cost being 400 and 600 pesos - or US \$ 17 and US \$26 - respectively) with the remainder subsidized by the Canadian Embassy. Filters in Cajuco cost the user 200 pesos (US \$9), with the remainder of the price subsidized by the Rotary

¹² U.S. prices were calculated using the average exchange rate from January 2002 to December 2004 rounded to the nearest peso (\$1 US = \$RD 23). Monthly exchange rates are listed in Appendix C.

Club. In Las Matas de Santa Cruz, filters sold for the unsubsidized prices of 1000 and 1500 pesos (US \$43 to US \$65). Finally, filters in Los Dominguez, Playa Oeste and Javillar de Costambar were subsidized by the Rotary Club under the direction of Robert Hildreth. The filters in Los Dominguez and Playa Oeste cost the user 500 pesos (US \$22), and those in Javillar de Costambar cost the user 200 pesos (US \$9). Table 4.1 gives the cost of the filter in Dominican and United States currency, as well as funding information and filter age.

Table 5.1: Filter Location, Cost and Funding Information.

| Location (number of filters) | Filter Age ^a | Funding Organization | Cost to User (Dominican pesos, US dollars) | Subsidized Cost (Dominican pesos, US dollars) | Total Cost (Dominican pesos, US Dollars) |
|------------------------------|-------------------------|---------------------------------|--------------------------------------------|-----------------------------------------------|------------------------------------------|
| MAO | | | | | |
| Hundidera (8) | 10 months | INDENOR | 600 (26) | 600 (26) | 1200 (52) |
| Entrada de Mao (6) | 2 years | Canadian Embassy | 400 (17) | 400 (17) | 800 (34) |
| Los Martinez (5) | 1.25 years | Canadian Embassy | 600 (26) | 600 (26) | 1200 (52) |
| DAJABON | | | | | |
| Cajuco (3) | 3 months | Rotary Club | 200 (9) | Unknown | Unknown |
| Las Matas de Santa Cruz (5) | 0.5-2 years | Sold at cost to user | 1000-1500 (43-65) | 0 (0) | 1000-1500 (43-65) |
| PUERTO PLATA | | | | | |
| Los Dominguez (4) | 6-12 months | Rotary Club/ Robert Hildreth | 200 (9) | Unknown | Unknown |
| Playa Oeste (6) | 1 year | Rotary Club/ Robert Hildreth | 200 (9) | Unknown | Unknown |
| Javillar de Costambar (3) | 1 year | Rotary Club/ Robert Hildreth | 500 (22) | Unknown | Unknown |

^aFilter age in January 2004

6 Methods

Several laboratory procedures were used during field work completed in January 2004 and during laboratory experiments completed Spring Term 2004. These procedures included membrane filtration for the enumeration of total coliform, thermotolerant coliform and *E. coli*, turbidity measurement and flow rate measurement.

6.1 Sample Collection

6.1.1 Sample Collection in the Dominican Republic

Field samples of unfiltered source water, pause water (water remaining in the filter's head space at all times), freshly filtered water collected from the BioSand filter tap, and post-treatment stored water were collected in sterile, 100-ml whirl-pack bags containing thiosulfate tablets. These bags were closed and stored in an insulated cooler containing ice packs until the group returned to the field laboratory. Time between collection and analysis was minimized by returning to the laboratory and beginning analysis immediately after collection of the last sample. Time between the collection of the first sample and analysis was no longer than four hours.



Figure 6.1: Team member Jeff Cerilles inspects the head space of a BioSand filter.

6.1.2 Sample Collection at MIT

Charles River water was obtained from a site near the Harvard Bridge (located at the intersection of Massachusetts Avenue and Memorial Drive in Cambridge, MA). A 20-liter plastic bucket on a rope was lowered to collect water. This water was brought back to the laboratory and used to create a 1:10 dilution of municipal sewage water obtained from the South Essex Sewerage

District wastewater treatment plant in Salem, MA by Susan Murcott. Two liters of sewage water was added to a bucket containing 18 liters of Charles River water. The waters were mixed with a large plastic spoon and allowed to warm to room temperature for filtration and analysis the following day.

Source water samples were obtained after stirring the sewage water / Charles River water mix prepared the previous day. A clean plastic beaker rinsed in tap water was dipped into the mix to collect a sample and set aside for analysis. Pause water samples were each obtained by carefully dipping a clean plastic beaker into the BioSand filter's head space, making sure not to disturb the biofilms developing at the sand-water interface. Filtered water samples were obtained directly from the filter's spout and were collected in a previously heat-sterilized glass beaker (sterilization process described in section 6.5.1).

6.2 Membrane Filtration

The membrane filtration procedure used during January and Spring 2004 followed Standard Method #9222 from Standard Methods for the Examination of Water and Wastewater (20th edition). A desired volume of sample was poured from a whirl-pack bag (or corresponding beaker) into a pre-sterilized Millipore stainless steel filter holder containing a 0.47 μm pore-size paper filter (Figure 6.2). If the desired volume was less than 100-ml, dilutions were performed whereby the sample was pipetted into the appropriate volume of deionized water (purchased locally at pharmacies in the Dominican Republic) or distilled water (available in the Building 1 lab), to result, in all cases, in a total volume of 100 ml. A hand-pump created a vacuum, drawing the water through the filter into a stainless steel collection vessel (see Figure 6.1). After filtration, the filter paper was placed in a disposable, sterile plastic petri dish on an absorbent pad onto which had been poured one ampoule of Millipore m-Coli blue broth (a broth that selects for total coliform and *E. coli*) during the field study and m-FC (which selects for thermotolerant coliform) broth during the laboratory study.



Figure 6.2: Membrane Filtration Apparatus.

6.3 Incubation

The petri dishes containing the filter and the broth were inverted and placed in a portable single-chamber Millipore incubator at the appropriate temperature (35°C for m-Coli blue broth, 44.5°C for m-FC broth) for 24 hours. The incubator was powered by an electric power source, barring power outages. In the event of a power outage, the power supply was switched to a rechargeable 12-volt nickel-cadmium battery.

After incubation, the petri dishes were removed and bacterial counts were recorded. The desired number of colonies per plate is between 20 and 80 colonies for m-Coli blue broth, and between 20 and 60 colonies for m-FC broth. Counts between 20 and 200 were considered valid data, as there is a range between the upper limit of statistical significance in a 1:100 dilution, for example, and the lower limit of detection on a 1:10 dilution.



Figure 6.3: Portable Single-Chamber Millipore Incubator.

6.4 Duplicates and Blanks

Duplicates and blanks, though not mentioned in later data analysis, were completed at each site visited in the Dominican Republic and on each day of laboratory testing at MIT. Duplicates were completed at random to verify total coliform or thermotolerant coliform counts in a given sample. Blanks were completed with the water used for diluting the samples. Completing blanks allowed the team to both verify the lack of coliform contamination of water used for dilutions and verify the complete sterilization of the membrane filtration devices.

6.5 Sterilization

Sterilization of field equipment was necessary to ensure that bacterial counts reflected only the bacteria in a given sample, not from contamination such as from the water used to rinse the equipment, water from previous samples, or contamination from the environment.

6.5.1 Glassware

Sterilized filter pads, petri dishes, absorbent pads, pipette tips (packed in small plastic bags) were brought to the Dominican Republic in the team's luggage. Glass graduated cylinders, flasks, and volumetric flasks were sterilized in a large, metal cooking pot (purchased in the Dominican Republic) containing boiling water. The items were boiled over a portable gas stove (borrowed from hosts in the Dominican Republic at each site) for 15 minutes. After boiling, the materials were removed from the pot with tongs and placed on a clean terrycloth towel to cool before use. At MIT, the glassware was sterilized in an oven set at 170°C for one hour. Once removed from the oven, glassware was capped with aluminum foil rinsed in isopropanol.

6.5.2 Pipette Tips

Plastic pipette tips were recycled by cleaning with laboratory soap (brought from the United States), hot water and a small wire brush for reuse. The soap was rinsed away with boiling water, and the tips were boiled for 30 minutes. After boiling, the tips were placed on Kimwipe sheets for a short amount of time (five minutes) to remove excess moisture. The tips were placed back in their plastic bags (using flame-sterilized tweezers) for future use.

6.5.3 Stainless Steel Filter Funnel Sterilization

Following the sterilization procedure outlined by Millipore, the filtration devices were sterilized by soaking a rope wick on the base of the device with methanol (obtained from a pharmacy in the Dominican Republic). The methanol was lit with a cigarette lighter (brought from the United States, available in the Dominican Republic). The vessel used to collect the water during filtration was placed over the filter assembly for 10 to 15 minutes. A formaldehyde byproduct of the ignited methanol sterilized the filter assembly.

6.6 Turbidity

Turbidity of water samples was determined in the field by placing a 5-ml aliquot of sample in a sample cell. The sample cell was placed in a Hach Pocket Turbidimeter™ and covered with the turbidimeter's plastic cap. The reading was recorded and the process was repeated a minimum of two more times for accuracy. These readings were then averaged. A Hach 2100P Turbidimeter™ was used during the laboratory study. Prior to all field and lab work, turbidimeters were standardized using Formazin standards following the procedure outlined in the user manuals that accompany the Hach turbidimeter kits.

6.7 Flow Rate

Filter flow rates were measured using two different methods while in the Dominican Republic. While in Mao, flow rates were measured by filling the filter to a level approximately 10 centimeters above the diffuser plate. Discharged water was collected in a one-liter plastic beaker. The time required for 200 ml of water to flow through the filter was recorded, and the rate was determined. In Dajabon and Puerto Plata, the method was changed on the advice of our host, Dr. Jan Tollefson, founder of the Canadian nongovernmental organization “Add Your Light,” the group responsible for the BioSand filter program in the Dominican Republic. For consistency with the method and data already collected on BioSand filter flow rates in the Dominican Republic, Dr. Tollefson advised the team to fill the concrete filter to the top and measure the maximum flow rate by recording either the time it took one liter of water to flow through the filter or the volume of water filtered in one minute, whichever came first.

6.8 Bacterial Disposal

After the bacterial plates had been counted, a 1:10 dilution of household bleach and water was applied to each plate. In an effort not to leave waste in the Dominican Republic, these plates were wrapped securely in plastic bags and lab tape for disposal upon returning to the United States. During the spring laboratory experiments at MIT, the bacteria were killed in the same manner and the dishes were thrown away.

6.9 Interview Methods

During the study in the Dominican Republic, team members developed a survey consisting of a set of water and filter usage, as well as a set of observational questions. The questions in this survey were intended to be answered by the member of the household charged with filter care. The purpose of first portion of the survey was to gather simple information about persons in the BioSand filter user demographic. This information included the address, telephone number (if the family had one), and ages of all persons using water from the BioSand filter, regardless of whether or not they lived in the household containing the filter. Standard of living information on floor type, latrine type and vehicle type was collected by another team member not participating in the interview process.

The next portion of the survey covered water sources and treatment. Gathering data on water sources would allow for comparison in water quality among different sources (when used in conjunction with bacterial plate count data), as well as giving the surveyor an idea of the type of sources encountered in the Dominican Republic. Answers to questions on water treatment (before purchasing the BioSand filter) indicate what resources are available, as well as giving the surveyor an idea how much money a family can devote to water treatment (i.e. boiling water is more expensive than simple cloth filtration).

The third portion of the survey addresses BioSand filter use, maintenance and water storage. By obtaining specific information on filtered water use, the surveyor is able to explore common water uses in a specific area as well as linking types of water use to the volume of water filtered. Obtaining maintenance information has twofold benefits. The data can be interpreted to show consistency in maintenance in a community as well as adherence to the maintenance methods

taught during filter installation. Collecting water storage information allows the surveyor to both learn about local storage vessels and possible routes of recontamination. Comparing storage vessel type with coliform testing results allows the surveyor to discern which water storage vessels fail to keep filtered water clean.

The purpose of this survey is to obtain general BioSand filter use data that can be interpreted to the desired degree of specificity. Conclusions drawn from the survey can be as broad as study-wide water use categorization, or as narrow as a comparison of storage vessel contamination between two homes using the same water source. The survey is designed to be useful to the team visiting the Dominican Republic in January 2004 as well as persons from nongovernmental organizations and other groups seeking information on BioSand filter use and performance. English and Spanish language versions of the survey are available in Appendices B and C, respectively.

7 Quantitative Results

7.1 Bacterial Plate Count Analysis

A total of 236 membrane filtration tests were completed during field work in the Dominican Republic during January of 2004. These tests were from source water, pause water, filtered water and stored water samples obtained from the 45 filters visited. The 236 tests included multiple dilutions, blanks, and duplicates. Blanks were completed each day, and all came out blank. Due to the limited three-week time period and due to higher than expected bacterial counts of source waters (10^1 to 10^4), many of the counts recorded during the field study were outside of the Standard Methods-prescribed range of detection for plate counts for total coliform between 20 and 80 colony forming units/100 ml (Standard Methods for the Examination of Water and Wastewater 20th Edition, 1998, Method #9222). Other results, however, did fall in the statistically valid range from 1 to 200 CFU/100 ml. Counts between one and 200 can be used if a 95% confidence interval ($c \pm 2c^{1/2}$) is calculated.

If source water and treated water values fell within the prescribed range, percent removal was calculated using those values. Equation 7.1 was used to calculate percent removal. In order to make better use of the data obtained, plate counts and estimates above 200 were assigned to the value 200+. By assigning a value greater than 200 to 200+, the data can be used to estimate minimum and maximum percent removal. Minimum percent removal values were calculated when the source water bacterial count was assigned the value of 200+ and the filtered water bacterial count falls in the prescribed range from one to 200. Maximum percent removal values were calculated when the source water bacterial count fell in the aforementioned prescribed range and the filtered water count was assigned the value of 200+. Percent removal was not calculated if both values were assigned to 200+. It should be emphasized that this technique is not approved as a standard method, and was only used for estimation purposes and in order to glean some general patterns from the data.

$$\text{Percent Removal} = \left(\frac{\left(\left(\frac{100}{\text{Volume Source Water Sample}} \right) \cdot (\text{Source Count}) \right) - \left(\frac{100}{\text{Volume Filtered Water Sample}} \right) \cdot (\text{Filtered Count})}{\left(\frac{100}{\text{Volume Source Water Sample}} \right) \cdot (\text{Source Count})} \right) \cdot 100$$

Equation 7.1: Percent Removal.

After incorporating estimates, data from 28 of the 45 filters remained. Eight of the 28 filters remaining were near Mao, with six of the filters in Hunidera and four located in Entrada de Mao. Six of the 28 filters were near Dajabon, with three filters each in Cajuco and Las Matas de Santa Cruz. The remaining 12 of the 28 filters were located in the vicinity of Puerto Plata, with five in Playa Oeste, four in Los Dominguez, and three in Javillar de Costambar. These filter-specific removal rates and adjusted total coliform values are presented in Appendix D. Unadjusted total coliform data is available in Appendix E.

7.1.1 Source Water Total Coliform and E. coli Counts

Source water contamination varied from location to location, with the three communities near Mao showing the most consistent degree of contamination. Total coliform contamination in these three communities varied by less than a factor of two (1044 to 2000+ CFU/100 ml). The largest degree of variation of contamination occurred near Puerto Plata, with total coliform counts ranging from 344 to 9682 CFU/100 ml. The lowest total coliform source water was observed in Javillar de Costambar (344 CFU/100 ml). The highest level of total coliform contamination was in Playa Oeste (9682 CFU/100 ml). The lowest *E. coli* contamination occurred in Los Dominguez (255 CFU/100 ml), and the highest degree of *E. coli* contamination occurred in Hundidera (10 CFU/100 ml).

The lowest and highest counts of *E. coli* contamination were not observed in the areas corresponding to the lowest and highest counts of total coliform contamination. Total coliform contamination is not always linked to water in which fecal coliform contamination is present, and it is for this reason that total coliform data is not the best indicator (World Health Organization Guidelines for Drinking Water Quality, 3rd Ed., Section 4.2.1, 1997). Source water total coliform and *E. coli* concentrations, as well as the percent of total coliform corresponding to *E. coli* contamination, is presented in Table 7.1. Figure 7.1 compares source water contamination by *E. coli* and total coliform. It should be noted that all values in this table are averages.

Table 7.1: Average Source Water *E.coli* and Total Coliform Counts. January 2004.

| Location and Number of Filters | Source Water <i>E. coli</i> Concentration (CFU/100 ml) | Source Water Total Coliform Concentration (CFU/100 ml) | Percent of Total Coliform Consisting of <i>E. coli</i> |
|--------------------------------|--------------------------------------------------------|--------------------------------------------------------|--------------------------------------------------------|
| MAO | | | |
| Hundidera (n=9) | 255 | 1044 | 24% |
| Entrada de Mao (n=6) | 252 | 1873 | 13% |
| Los Martinez (n=7) | 17 | 2000+ | <1% |
| DAJABON | | | |
| Cajuco (n=3) | 267 | 1937 | 14% |
| Las Matas de Santa Cruz (n=5) | 128 | 9360 | 1% |
| PUERTO PLATA | | | |
| Playa Oeste (n=6) | 33 | 9682 | 0% |
| Los Dominguez (n=4) | 10 | 1086 | 1% |
| Javillar de Costambar (n=3) | 13 | 344 | 4% |

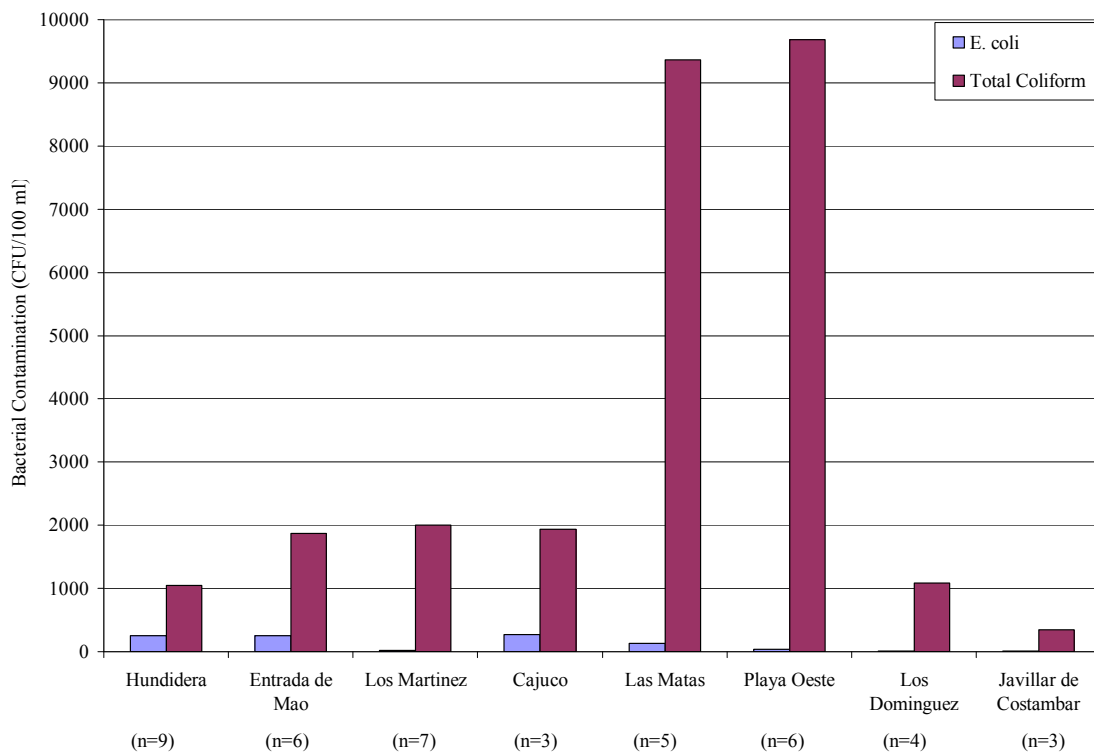

Figure 7.1: Total Coliform and *E. coli* Contamination in Dominican Source Waters. January 2004.

7.1.2 Filtered Water Total Coliform and *E. coli* Counts, Percent Removal

Five of the eight communities (Hundidera, Entrada de Mao, Cajuco, Las Matas de Santa Cruz, and Playa Oeste) in which filters were tested show an average total coliform removal of 80% or greater. Of the remaining three communities, Los Dominguez and Javillar de Costambar, showed close to zero or negative removal. All of the data from Los Martinez was revalued by estimation as explained in Section 7.1, and percent removal could not be calculated. Removal rates ranged from 90% in Cajuco to -307% in Javillar de Costambar. The highest average filtered water total coliform contamination occurred in Las Matas de Santa Cruz (1614 CFU/100 ml), and the lowest average filtered water total coliform contamination occurred in Hundidera (138 CFU/100 ml).

Average *E. coli* removal rates were greater than or equal to 50% in five of the eight communities: Hundidera, Entrada de Mao, Cajuco, Las Matas de Santa Cruz, and Los Dominguez. Removal was close to zero in Los Martinez, and negative in both Playa Oeste and Javillar de Costambar. The highest degree of *E. coli* removal occurred in Entrada de Mao (97% removal), and the lowest occurred in Playa Oeste (-900%). The lowest average *E. coli* concentrations were found in Las Matas de Santa Cruz (2 CFU/100 ml). The highest *E. coli* concentrations were found in Playa Oeste, one of the communities showing negative removal. Table 7.2 compares total coliform and *E. coli* counts and removal rates in source water and filtered water. Figure 7.2 shows the fraction of total coliform consisting of *E. coli* in the eight communities tested. The discrepancies between total coliform percent removal and *E. coli* percent removal are in the Communities of Playa Oeste and Los Dominguez, where one community's total coliform results show positive percent removal, but the same community's *E. coli* removal is negative.

Table 7.2: Average Total Coliform and *E. coli* Counts in Source Waters and Filtered Waters. January 2004.

| Location | Source <i>E. coli</i> (CFU/100 ml) | Filtered <i>E. coli</i> (CFU/100 ml) | <i>E. coli</i> Percent Removal | Source Total Coliform (CFU/100 ml) | Filtered Total Coliform (CFU/100 ml) | Total Coliform Percent Removal |
|-------------------------|------------------------------------|--------------------------------------|--------------------------------|------------------------------------|--------------------------------------|--------------------------------|
| MAO | | | | | | |
| Hundidera | 255 | 26 | 90% | 1044 | 138 | 87% |
| Entrada de Mao | 252 | 8 | 97% | 1873 | 209 | 89% |
| Los Martinez | 17 | 17 | 2% | 2000+ | 200+ | - |
| DAJABON | | | | | | |
| Cajuco | 267 | 33 | 88% | 1937 | 397 | 80% |
| Las Matas de Santa Cruz | 128 | 2 | 98% | 9360 | 1614 | 83% |
| PUERTO PLATA | | | | | | |
| Playa Oeste | 33 | 333 | -900% | 9682 | 1388 | 86% |
| Los Dominguez | 10 | 5 | 50% | 1086 | 1113 | -2% |
| Javillar de Costambar | 13 | 35 | -163% | 344 | 1400 | -307% |

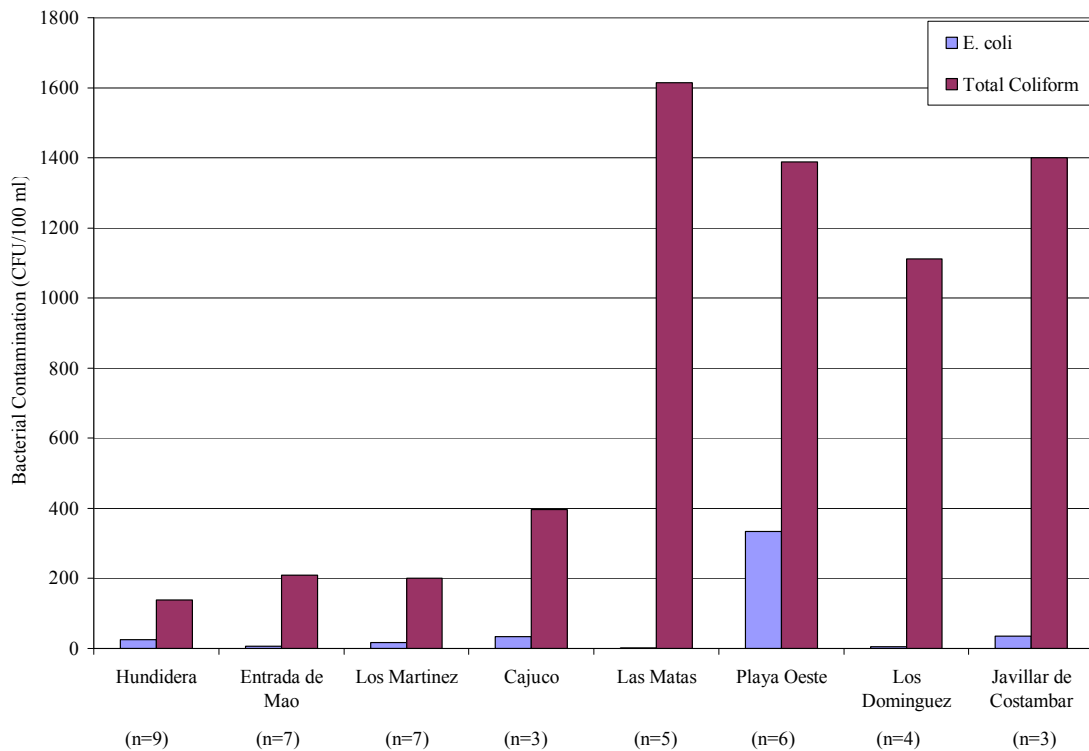

Figure 7.2: Total coliform and *E. coli* Contamination in Filtered Waters in the Dominican Republic.

7.1.3 Stored Water Total Coliform Counts

Stored water samples were not taken at many of the homes visited. A total of 11 storage samples were taken out of the 45 filters (of these 11 values, only four have values for both source water and filtered water total coliform and *E. coli* counts). Obtaining stored water samples was difficult due in part to availability (filter owners choosing to store their water in the refrigerator often froze the water). In some cases, obtaining a storage sample required dipping the whirl-pack bag into an open storage container, possibly introducing contaminants from team members' hands.

Total coliform data for filters Hundayera 1 and Los Dominguez 1 in Tables 7.3 shows that stored water had higher total coliform counts than filtered water at the same locations, indicating coliform found in storage vessels was reintroduced into the freshly filtered water. Storage data in Cajuco shows no recontamination (see Chapter 8 Section 3 for further discussion of this finding). *E. coli* data for the same four filters is presented in Table 7.4 for comparison. Figure 7.3 gives a visual representation of recontamination.

Table 7.3: Source, Filtered and Stored Water Total Coliform Contamination. January 2004.

| Filter Location and Number | Source Water Total Coliform Contamination (CFU / 100 ml) | Filtered Water Total Coliform Contamination (CFU / 100 ml) | Stored Water Total Coliform Contamination (CFU / 100 ml) |
|-----------------------------------|-----------------------------------------------------------------|-------------------------------------------------------------------|-----------------------------------------------------------------|
| Hundayera 1 | 100 | 102 | 173 |
| Cajuco 2 | 10 | 20 | 0 |
| Cajuco 3 | 3500 | 380 | 130 |
| Los Dominguez 1 | 294 | 8990 | 4000+ |

Table 7.4: Source, Filtered and Stored Water *E. coli* Contamination. January 2004.

| Filter Location and Number | Source Water <i>E. coli</i> Contamination (CFU / 100 ml) | Filtered Water <i>E. coli</i> Contamination (CFU / 100 ml) | Stored Water <i>E. coli</i> Contamination (CFU / 100 ml) |
|-----------------------------------|-----------------------------------------------------------------|-------------------------------------------------------------------|-----------------------------------------------------------------|
| Hundayera 1 | 0 | 6 | 15 |
| Cajuco 2 | 0 | 0 | 0 |
| Cajuco 3 | 800 | 100 | N/A |
| Los Dominguez 1 | 0 | 0 | N/A |



Figure 7.3: Total Coliform plates from 10 ml of source water, 100 ml of filtered water, and 100 ml of stored water in Mao, Dominican Republic, January 9, 2004.

7.2 Flow Rates

Flow rates were highest in Javillar de Costambar, with an average rate of 1.9 L/min (116 L/hr). The lowest flow rates were found in Cajuco (0.9 L/min, 54 L/hr). Las Matas de Santa Cruz's flow rates were the most consistent as a group, with a standard deviation of only 0.08 L/min (4.8 L/hr). The average flow rate for filters tested in Dajabon and Puerto Plata was 1.3 L/min (78 L/hr), and average flow rates for the individual communities visited are shown in Table 7.5. A distribution of the flow rates from Dajabon and Puerto Plata is shown in Figure 7.4. Flow rates from Mao were measured using a different method from that used in Dajabon and Puerto Plata (this method is described in Chapter 5). These data are presented in Table 7.6. It is unknown whether or not the initial flow rates (upon installation) in Los Dominguez, Javillar de Costambar and Playa Oeste were close to the recommended rate of 1 L/min (60 L/hr), or were elevated from the beginning. If they were indeed elevated, signs of poor removal would have been present from the beginning.

Table 7.5: Average, Standard Deviation and Range of Flow Rates. January 2004. Measured using the first flow rate measurement method described in Section 6.7.

| Location | Average L/min (L/hr) | Standard Deviation L/min (L/hr) | Range L/min (L/hr) |
|-------------------------------|-------------------------|------------------------------------|-----------------------|
| DAJABON | | | |
| Cajuco (n=3) | 0.9 (54) | 0.5 (30) | 0.3-1.3 (18-78) |
| Las Matas de Santa Cruz (n=5) | 1.0 (60) | 0.08 (4.8) | 1.0 -1.1(60-66) |
| PUERTO PLATA | | | |
| Los Dominguez (n=4) | 1.4 (84) | 0.2 (12) | 1.3-1.7 (78-102) |
| Javillar de Costambar (n=3) | 1.9 (114) | 0.3 (17) | 1.7-2.3 (102-138) |
| Playa Oeste (n=6) | 1.4 (84) | 0.3 (18) | 0.8-1.6 (48-96) |

Table 7.6: Average, Standard deviation and Range of Flow Rates near Mao. January 2004. Measured using the section flow rate measurement method described in Section 6.7.

| Location | Average L/min (L/hr) | Standard Deviation L/min (L/hr) | Range L/min (L/hr) |
|----------------------|-------------------------|------------------------------------|-----------------------|
| MAO | | | |
| Hundidera (n=9) | 0.8(48) | 0.4 (24) | 0.4-1.8 (24-108) |
| Entrada de Mao (n=7) | 0.5(30) | 0.2 (12) | 0.2-0.7 (12-42) |
| Los Martinez (n=6) | 1.1 (66) | 0.5 (30) | 0.3-1.5 (18-90) |

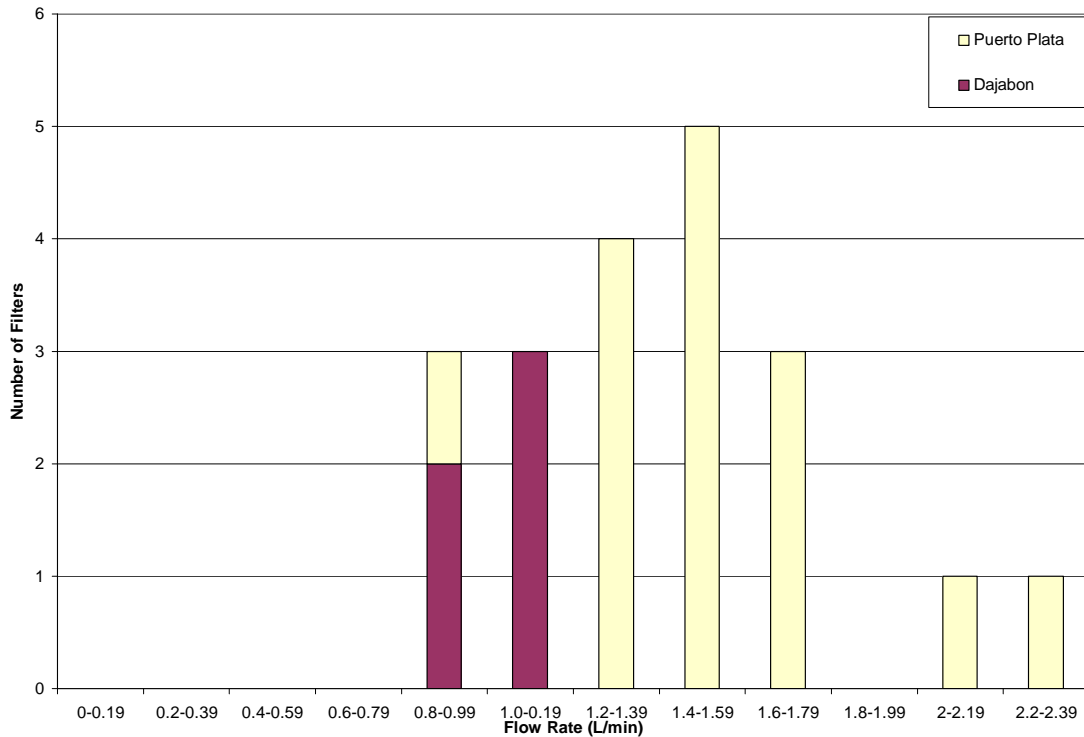

Figure 7.4: Flow Rates Measured During Field Work in the Dominican Republic, January 2004.

7.3 Turbidity Removal

7.3.1 Source Water and Filtered Water Turbidity

While total coliform source counts were high, source water turbidities were relatively low. It is recommended that water treated using a slow sand filter has a turbidity of less than 5 NTU (Cleasby, 1991). Of the 43 source water samples tested, only seven had turbidities greater than or equal to 5 NTU. Average source water turbidity was higher than that of the filtered water in each location. Source water turbidity ranged from 0.7 NTU at a home in Los Martinez to 9.6 NTU at a home in Los Dominguez. Filtered water turbidity ranged from a low of 0.3 NTU in Los Martinez to a high of 5.1 NTU in Entrada de Mao. Filter-specific turbidity data (grouped by community) is presented in Table 7.7. Distributions of source and filtered water turbidities are presented in Figure 7.4 and Figure 7.5, respectively.

Table 7.7: Filter-Specific Pause, Source and Filtered Water Turbidity. January 2004.

| Filter | Date | Pause Water Turbidity (NTU) | Source Water Turbidity (NTU) | Filtered Water Turbidity (NTU) | Percent Removal |
|--------------------------|-------------|------------------------------------|-------------------------------------|---------------------------------------|------------------------|
| MAO | | | | | |
| Entrada de Mao 1 | 1/9/04 | 17.8 | 2.0 | 5.1 | -159% |
| Entrada de Mao 2 | 1/9/04 | 1.1 | 2.0 | 0.4 | 80% |
| Entrada de Mao 3 | 1/9/04 | | 1 | 1.3 | -27% |
| Entrada de Mao 4 | 1/9/04 | | | 7 | |
| Entrada de Mao 5 | 1/9/04 | 3.2 | 2.6 | 1.7 | 35% |
| Entrada de Mao 6 | 1/9/04 | | 3.5 | 0.9 | 74% |
| Entrada de Mao 7 | 1/9/04 | 11.2 | 6.3 | 2.7 | 57% |
| Entrada de Mao 8 | 1/9/04 | 6.9 | 1.5 | 0.8 | 45% |
| Juan's Home | 1/9/04 | 4.6 | 5.0 | 1.5 | 70% |
| Hundidera 1 | 1/8/04 | | | 0.7 | |
| Hundidera 2 | 1/8/04 | 1.2 | 1.3 | 0.6 | 54% |
| Hundidera 3 | 1/8/04 | | 3.0 | 0.9 | 70% |
| Hundidera 4 | 1/8/04 | 3.7 | 8.6 | 0.3 | 97% |
| Hundidera 5 | 1/8/04 | | 4.0 | 0.5 | 87% |
| Hundidera 6 | 1/8/04 | | 2.2 | 3.1 | -41% |
| Hundidera 7 | 1/8/04 | | 5.6 | 1.1 | 80% |
| Hundidera 8 | 1/8/04 | 0.7 | 1.0 | 1.5 | -52% |
| Hundidera 9 | 1/8/04 | 1 | 1.7 | 0.4 | 80% |
| Los Martinez 1 | 1/10/04 | 3.1 | 3.9 | 0.9 | 77% |
| Los Martinez 2 | 1/10/04 | 1.4 | 1.7 | 0.8 | 55% |
| Los Martinez 3 | 1/10/04 | 1.3 | 3.3 | 1.4 | 57% |
| Los Martinez 4 | 1/10/04 | 2.0 | 2.2 | 1.1 | 49% |
| Los Martinez 5 | 1/10/04 | 4.2 | 5.0 | 1.4 | 72% |
| Los Martinez 6 | 1/10/04 | 13.1 | 2.4 | 1.3 | 46% |
| Los Martinez 7 | 1/10/04 | 1.9 | 2.0 | 1.2 | 42% |
| DAJABON | | | | | |
| Cajuco 1 | 1/14/04 | 1.9 | 3.3 | 1.2 | 65% |
| Cajuco 2 | 1/14/04 | 1.0 | 1.4 | 2.3 | -66% |
| Cajuco 3 | 1/14/04 | 1.0 | 5.6 | 2.3 | 59% |
| Las Matas de Santa Cruz1 | 1/15/04 | 8.6 | 0.7 | 0.7 | -10% |
| Las Matas de Santa Cruz2 | 1/15/04 | 1.7 | 1.3 | 0.9 | 32% |
| Las Matas de Santa Cruz3 | 1/15/04 | 0.5 | 0.6 | 0.5 | 25% |
| Las Matas de Santa Cruz4 | 1/15/04 | 2.7 | 2.1 | 1.9 | 11% |
| Las Matas de Santa Cruz5 | 1/15/04 | 1.0 | 3.0 | 0.3 | 91% |
| PUERTO PLATA | | | | | |
| Playa Oeste 1 | 1/20/04 | 0.8 | 1.4 | 1.0 | 31% |
| Playa Oeste 2 | 1/20/04 | 3.6 | 1.6 | 1.3 | 17% |
| Playa Oeste 3 | 1/20/04 | 0.9 | 1.5 | 0.7 | 50% |
| Playa Oeste 4 | 1/20/04 | 1.4 | 1.4 | 1.3 | 5% |
| Playa Oeste 5 | 1/20/04 | 1.3 | 2.3 | 1.6 | 30% |
| Playa Oeste 6 | 1/20/04 | 1.0 | 1.2 | 0.7 | 37% |
| Los Dominguez 1 | 1/21/04 | 9.0 | 9.5 | 3.4 | 64% |
| Los Dominguez 2 | 1/21/04 | 2.3 | 3.7 | 1.9 | 50% |
| Los Dominguez 3 | 1/21/04 | 2.8 | 3.6 | 2.1 | 41% |
| Los Dominguez 4 | 1/21/04 | 4.1 | 2.5 | 2.5 | 0% |

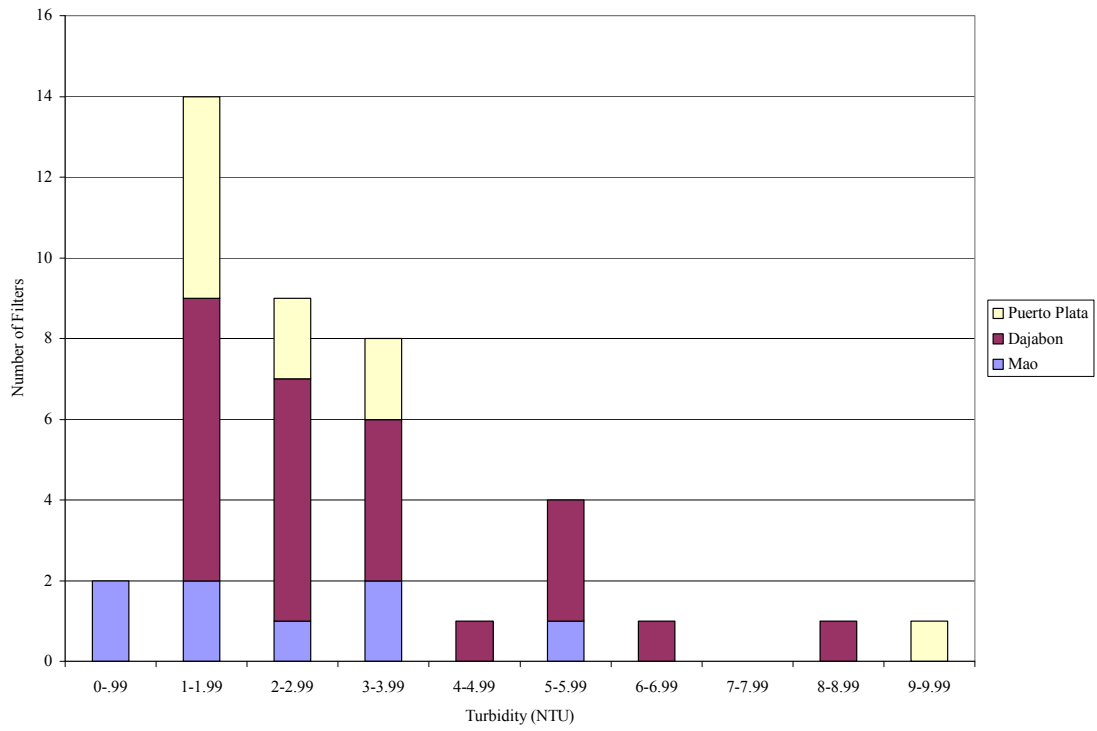

Figure 7.5: Source Water Turbidity Distribution (n=43 filters). January 2004.

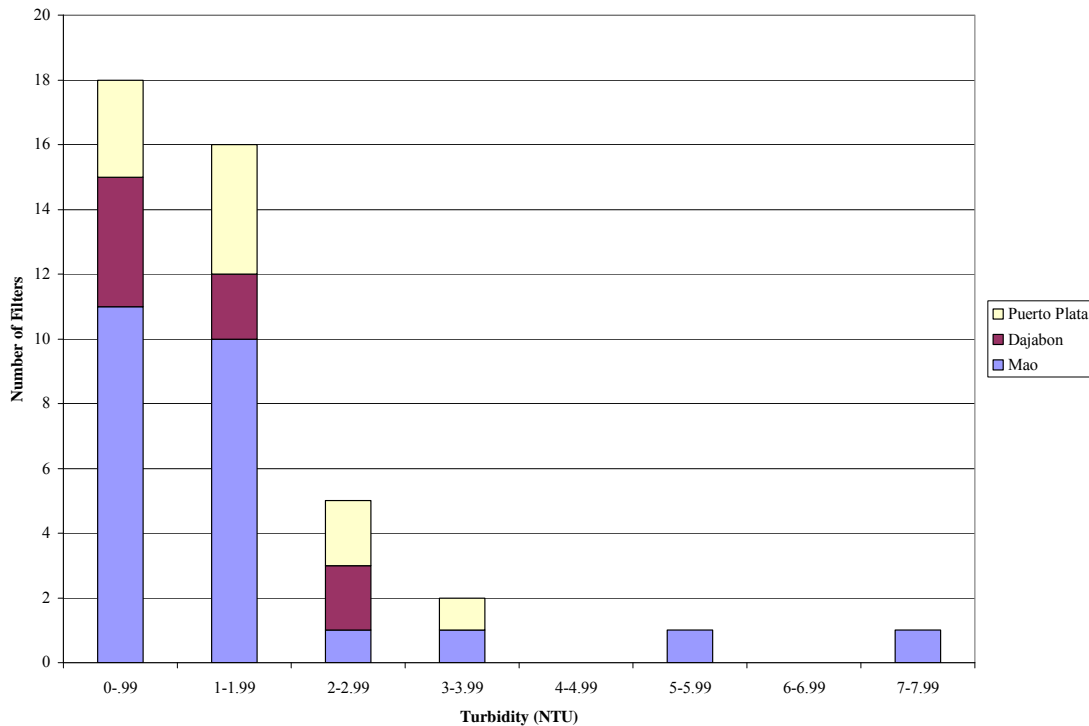

Figure 7.6: Filtered Water Turbidity Distribution (n=43 filters). January 2004.

Though turbidity removal rates of individual filters were negative in six cases (filters Entrada de Mao 1, Entrada de Mao 3, Hundidera 6, Hundidera 8, Cajuco 2, and Las Matas de Santa Cruz 1), average removal rates were positive in each location visited (Table 7.8). Average removal rates were highest near Mao (specifically in Hundidera). Removal rates near Dajabon and Puerto Plata were between 28% and 49%, which is on the lower end on the range of removal rates encountered near Mao (40% to 70%). Turbidity readings were not taken in Javillar de Costambar due to an inability to get stable readings. Community-averaged turbidity data is shown in Table 7.8.

Table 7.8: Average Source Water Turbidity, Average Filtered Water Turbidity, and Average Turbidity Percent Removal Rates. January 2004.

| Location (number of turbidity tests) | Average Source Water Turbidity (NTU) | Average Filtered Water Turbidity (NTU) | Average Percent Removal |
|--------------------------------------|--------------------------------------|----------------------------------------|-------------------------|
| MAO | | | |
| Hundidera (9) | 3.0 | 1.8 | 70% |
| Entrada de Mao (8) | 3.4 | 1.0 | 40% |
| Los Martinez (7) | 2.9 | 1.2 | 60% |
| DAJABON | | | |
| Las Matas de Santa Cruz (5) | 1.5 | 0.8 | 45% |
| Cajuco (3) | 3.4 | 1.9 | 44% |
| PUERTO PLATA | | | |
| Playa Oeste (6) | 1.6 | 1.1 | 28% |
| Los Dominguez (4) | 4.8 | 2.5 | 49% |

7.3.2 Pause Water Turbidity

Turbidity of pause water followed no trends. There were no common relationships between turbidity data taken in the vicinity of any one city. Because pause water turbidity depends on both the turbidity of the source water and the time pause water has been undisturbed and susceptible to sedimentation, readings were expected to be quite variable from location to location (Table 7.9).

Table 7.9: Average Pause Water Turbidity. January 2004.

| Location (number of turbidity tests) | Average Pause Water Turbidity (NTU) | Standard Deviation |
|--------------------------------------|-------------------------------------|--------------------|
| MAO | | |
| Hundidera (9) | 7.5 | 6.1 |
| Entrada de Mao (8) | 1.7 | 1.4 |
| Los Martinez (7) | 3.9 | 4.2 |
| DAJABON | | |
| Las Matas de Santa Cruz (5) | 2.9 | 3.3 |
| Cajuco (3) | 1.3 | 0.5 |
| PUERTO PLATA | | |
| Playa Oeste (6) | 1.5 | 1.0 |
| Los Dominguez (4) | 4.6 | 3.1 |

8 Qualitative Data Analysis: Survey Results

A total of 48 interviews were conducted during field studies completed in the Dominican Republic during January 2004. Average family size ranged from two people in Cajuco (where three interviews were completed) to six people in Javillar de Costambar, Mao, and Playa Oeste (Table 8.1).

Table 8.1: Number of Interviews per Site and Family Age Distribution by Location. January 2004.

| <i>Location (Number of Interviews)</i> | <i>Babies</i> | Children (ages 2-16) | Adults (ages 16+) | Family Size |
|----------------------------------------|---------------|-------------------------|----------------------|-------------|
| MAO | | | | |
| Hundidera (9) | 0 | 1 | 3 | 4 |
| Mao (8) | 0 | 2 | 4 | 6 |
| Los Martinez (7) | 0 | 2 | 3 | 5 |
| DAJABON | | | | |
| Cajuco (3) | 0 | 0 | 2 | 2 |
| Las Matas de Santa Cruz (5) | 0 | 1 | 4 | 5 |
| PUERTO PLATA | | | | |
| Playa Oeste (6) | 0 | 1 | 5 | 6 |
| Los Dominguez (5) | 0 | 2 | 3 | 5 |
| Javillar de Costambar (5) | 1 | 2 | 3 | 6 |
| Average | 0 | 1 | 3 | 4 |

8.1 Background Observations

General quality of life observations (bathroom facility type, floor type and motor vehicle availability) were made at homes visited. Bathroom facility observations were made at 37 homes. The bathroom types can be split into three categories: pit latrines, ventilated improved pit latrines (VIPs) and flush toilets. All of the homes near Mao had pit latrines (21 of 21 observations), only one of which was a VIP latrine. All three types of bathroom were observed near Dajabon. Two homes had pit latrines, two had flush toilets and one had a VIP latrine (five observations total). Of the eleven facilities observed near Puerto Plata, 10 were flush toilets and one was a pit latrine. Figure 8.1 is a distribution of bathroom facility types observed while in the Dominican Republic.

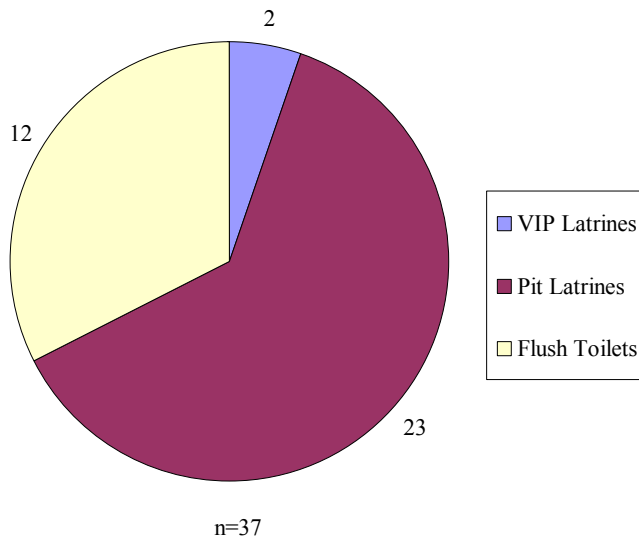

Figure 8.1: Bathroom Facility Types Observed in the Dominican Republic. January 2004.

Floor type data was recorded at 19 of homes the 48 homes. The majority of these homes had a finished floor constructed from tile or concrete. Two homes in Mao and one home in Los Martinez had dirt floors. The remaining 16 homes, located near Dajabon and Puerto Plata, had finished floors of concrete (15) or tile (one home in Los Dominguez).

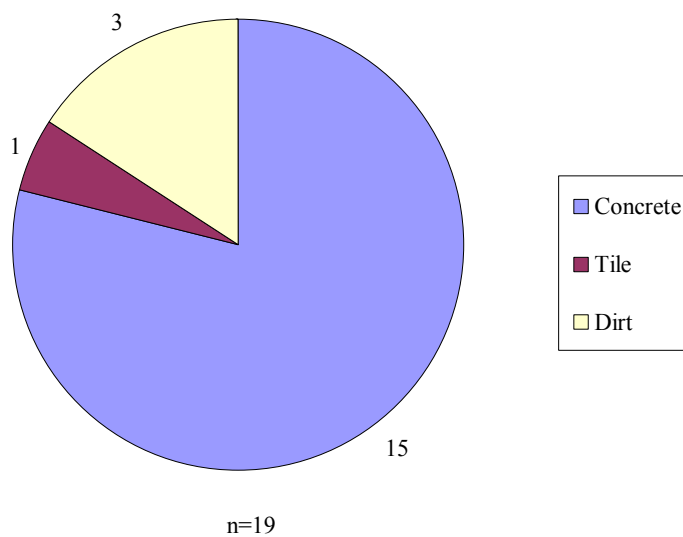

Figure 8.2: Floor Types Observed in the Dominican Republic. January 2004.

Motor vehicle data was not available for many homes, as the entire family was not home at the time the interview took place in the majority of cases. Family members were away at work in many cases and may have been using the family vehicle (the interviews took place in the middle of the day). Bathroom facility, floor type and motor vehicle data were observations, not survey questions, as the interviewee may have perceived these questions to be invasive and unrelated to BioSand filter use. All recorded quality of life data is available in Table 8.2.

8.2 Water Sources and Filter Use

8.2.1 Water Sources

Persons interviewed reported several main water sources: trucks, rainwater, and tap water. Source popularity depended on location, and single families often relied on multiple water sources (Table 8.3). In Hundidera, Mao, and Los Martinez, all 23 families interviewed use water from trucks as their main source. The trucks in Mao bring water from both Rio Mao and INAPA, the local water authority. The source of the INAPA water was not determined by team members. Of the 23 families, eight also use rainwater as a water source. The three homes visited in Cajuco also receive water from the INAPA truck, though one respondent uses rainwater as her main source and only uses water from INAPA when her rainwater supply is low.

In Las Matas de Santa Cruz, the five persons interviewed report use of multiple water sources. Four of the five respondents use rainwater, three of the five use water from a truck, and one uses water supplied by plumbing. In Los Dominguez and Playa Oeste, all nine users interviewed use tap water (available several hours daily, depending on exact location) as their major water source. One interviewee told the team that rainwater should not be used near Puerto Plata due to contamination air pollution, though one person interviewed in Javillar de Costambar did use rainwater as a secondary source. Three of the five respondents in Javillar de Costambar use tap water as their main source, and one buys water from a truck.

8.2.2 Water Treatment Previous to Purchasing the BioSand Filter

Before purchasing BioSand filters, people interviewed treated their water in a variety of ways. The most popular way to “treat” water was to buy bottled water (18 of 48 surveys), with chlorination as a close second (14 responses). Other options included boiling water (11),

drinking the water straight from the source (7), filtering turbid water with a cloth (4), not buying bottled water due to the belief that it was contaminated (1), , and, and adding carbon from burned wood (1). Buying bottled water was the most popular choice near Puerto Plata (11 of 15 responses). No specific treatment option emerged as the most prevalent near either Dajabon or Mao.

8.2.3 Filter Age

BioSand filters near each major city tended to be of similar ages and costs. In Hundidera, the filters were all approximately 11 months old. Filters in Mao were close to two years old, while those in Los Martinez were the youngest, all having been in use for approximately one month. Filters in Cajuco were all three months old, while ages of those in Las Matas de Santa Cruz ranged from two months to two years. Filters in Javillar de Costambar and Playa Oeste are all one year old, and those in Los Dominguez were between six and twelve months old.

8.2.4 Filtered Water Uses

Drinking was the most popular use of water treated with the BioSand filter. Every family but one (this family had stopped using their filter) responded with this use (47 of 48 responses). Secondary uses included cooking (16 responses), bathing (22 responses), preparing beverages (three responses) and cleaning (three responses). Only five users reported that the taste of water treated by the BioSand filter was the same or worse than the taste of water previous to obtaining the filter. Figure 8.3 shows a distribution of secondary uses of water treated with the BioSand filter.

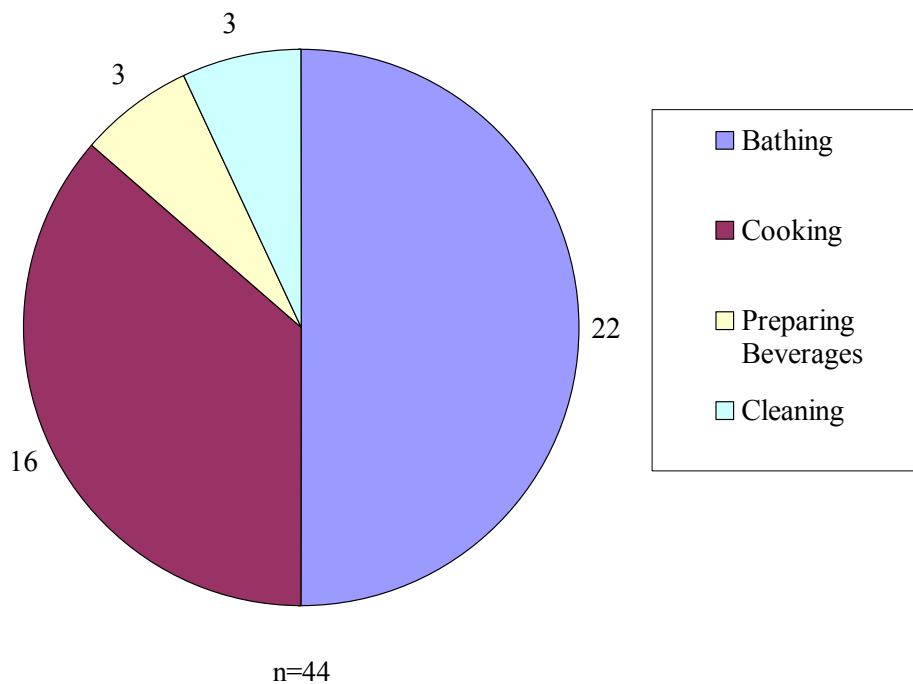

Figure 8.3: Secondary Uses of Water Treated by the BioSand Filter in the Dominican Republic.

8.3 Filter Maintenance and Water Storage

Maintenance

BioSand filter users are taught to clean their filters upon installation. They are also given a pamphlet or information that instructs them to clean the filter when flow rates drop to a trickle. Thirteen of the 48 persons interviewed had never needed to clean their filter. Of those people who had cleaned their filters, the majority hadn't needed to clean them in months. Only three people reported cleaning their filter on a weekly basis. These three respondents said they were told to clean their filters frequently, but they may have misunderstood the information they were given. Though cleanings are infrequent, most filter owners use their filters on an almost daily basis. No one interviewed used their filter less frequently than once a week (Table 8.3).

Storage

Filtered water was stored in a variety of ways. The most common way to store water was in a refrigerator (13 of 48 surveys). Other common ways to store water included buckets (covered

and uncovered), trash cans (covered or uncovered), five-gallon water bottles, and traditional water storage vessels (Table 8.4). Twenty-one people reported cleaning their water storage vessels with filtered water and chlorine. The other popular cleaning methods included rinsing the storage vessel with filtered water or wiping it with a towel. Five respondents did not clean their filtered water storage vessels at all.



Figure 8.4: Storage Vessels Seen in the Dominican Republic. January 2004.

8.4 Reported Health Effects

Ours was not a health or epidemiological study. Although a direct correlation between improved health and BioSand filter use was not intended during our January 2004 study, more than one-quarter of interviewees cited positive health effects since they began filter use. Seventeen of the 48 persons interviewed reported improved gastrointestinal health, the most common health

benefit users associated with their BioSand filters. Other positive effects included decreased occurrences of vaginal and other non-specified infections (four responses), disappearance of typhoid fever and the flu (one response each), clearing up of rashes (two responses) and a disappearance of warts (two responses). No negative health effects were reported.

Table 8.2: General Quality of Life Observations: Latrine Type, Floor Type and Transportation Type.

| | Mao | Dajabon | Puerto Plata |
|---------------------|-------------------------------------------------------------------------------------------------------------------------|----------------------------------------------------------------------------------------|----------------------------------------------------------------------------------------------------------------------------------------------|
| Latrine Type | Hundidera: Non ventilated-improved pit, or VIP, latrine (8) Mao: non-VIP (6), VIP (1) Los Martinez: Non-VIP (6) | Cajuco: Non-VIP (2) Las Matas de Santa Cruz: Internal bathroom (2), VIP latrine (1) | Playa Oeste: Internal bathroom (4) Los Dominguez: Internal bathroom (4) Javillar Costambar: Internal bathroom (2), non VIP latrine (1) |
| Floor Type | Hundidera: Data not taken Mao: Dirt Floor (2) Los Martinez: Dirt floor (1) | Cajuco: Concrete floor (3) Las Matas de Santa Cruz: Concrete floor (4) | Playa Oeste: Los Dominguez: Concrete floor (3), tile floor (1) Javillar Costambar: Concrete floor (5) |
| Transportation | Hundidera: Motor vehicle (4), motorcycle (1) Mao: Motor vehicle (1), motorcycle (2) Los Martinez: Motor cycle (1) | Cajuco: Motorcycle (1) Las Matas de Santa Cruz: Not recorded | Playa Oeste: Not recorded Los Dominguez: Not recorded Javillar Costambar: Not recorded |

Table 8.3: Water Sources, Filter Characteristics and Comparisons of Post and Pre-BioSand Filter Water Effects. January 2004.

| | Mao | Dajabon | Puerto Plata |
|------------------------------------------------|--------------------------------------------------------------------------------------------------------------------------------------------------------------------------------------------------------------------------------------------------------------------------------------------------------------------------------|-----------------------------------------------------------------------------------------------------------------------------------------------------------------------------------------|------------------------------------------------------------------------------------------------------------------------------------------------------------------------------------------------------------------------------------|
| Water Source | Hundidera: Truck (9), rainwater (4), walk to river (1) Mao: Truck (7), rainwater (2), purchase (1) Los Martinez: Truck (7), rainwater (2) | Cajuco: Prolino (European Union Non-governmental organization) cistern and water supply program (3) Las Matas de Santa Cruz: Truck (3), rainwater (4), piped water (1) | Playa Oeste: Tap available several hours daily (4) Los Dominguez: Tap (5) Javillar de Costambar: Tap (4), rainwater (1), truck (1) |
| Pretreatment (before purchasing filter) | Hundidera: Boil (2), chlorine (3), bought bottled water (1), never bought bottled water (1), added carbon from burned wood (1), nothing (3) Mao: boil (3), chlorine (5), cloth filtration (3), bought bottled water (1), nothing (1) Los Martinez: boil (4), chlorine (3), bought bottled water (2) | Cajuco: Chlorine (2), none (1) Las Matas de Santa Cruz: Chlorine (1), boil (1), cloth filtration (1), bought bottled water (3) | Playa Oeste: Bought bottled water (4), chlorine (1), nothing (1) Los Dominguez: Bought bottled water (4), rainwater (1), nothing (1) Javillar de Costambar: Bought bottled water (3), boiled (1) |
| Filter Age | Hundidera: 11 months (9) Mao: One month (7) Los Martinez: 21 months (7), 23 months (1) | Cajuco: Three months (3) Las Matas de Santa Cruz: Two months (1), six months (2), eight months (1), two years (1), not sure (1) | Playa Oeste: One year (4) Los Dominguez: Six to twelve months (5) Javillar de Costambar: One year (4) |
| Filter Price | Hundidera: 600 pesos (9) Mao: 400 pesos (7) Los Martinez: 600 pesos (8) | Cajuco: 200 pesos Las Matas de Santa Cruz: 1500 pesos (3), 1000 pesos (1) | Playa Oeste: 200 pesos (4), free (1) Los Dominguez: 250 pesos (1), 200 pesos (4) Javillar de Costambar: 500 pesos (4) |
| Use of Filtered Water | Hundidera: Drinking (9), bathing (6), washing dishes (1), milk (1) Mao: drinking (7), bathing (5), cooking (2), juice (1), ice (1) Los Martinez: Drinking (7), bathing (4), cooking (4) | Cajuco: Drinking (3), bathing (1), cooking (1) Las Matas de Santa Cruz: Drinking (5), bathing (1), cooking (1) | Playa Oeste: Drinking (5), cooking (3), bathing (1) Los Dominguez: Drinking (4), cooking (2), bathing (2), making juice (2), cleaning (2) Javillar de Costambar: Drinking (4), cooking (3), bathing (2) |
| Specific Health Effects | Hundidera: Rashes have healed(2), decreased occurrence of vaginal infection (3) Mao: Improved gastrointestinal health (5), fewer infections (2) Los Martinez: Improved gastrointestinal health(4), fewer infections (1) | Cajuco: Improved gastrointestinal health (3) Las Matas de Santa Cruz: Improved gastrointestinal health (1), typhoid fever gone (2), flu gone (1) | Playa Oeste: Improved gastrointestinal health (2), none (2) Los Dominguez: Improved gastrointestinal health (2),no more warts (2) Javillar de Costambar: None reported |
| Taste of Filtered Water | Hundidera: Better (6), occasionally bad due to river (1) Mao: Better (5), the same (1) Los Martinez: Better (6) | Cajuco: Better (2), bad at first, now better (1) Las Matas de Santa Cruz: Better (3) | Playa Oeste: Better (4), had to get used to it (1) Los Dominguez: Better (4), had to get used to it (1) Javillar de Costambar: Better (4) |

| | <i>Mao</i> | <i>Dajabon</i> | <i>Puerto Plata</i> |
|-----------------------------------------|--------------------------------------------------------------------------------------------------------------------------------------------------------------------------------------------------------------------------------------------------------------------------------------------------------------------------------------------------------------------------------------------------------------------------------------------------------------------|---------------------------------------------------------------------------------------------------------------------------------------------------------------------------------------------------|-----------------------------------------------------------------------------------------------------------------------------------------------------------------------------------------------------------------------------------------------------------------------------|
| How Often is the Filter Cleaned? | Hundidera: Three months ago (1), twice in the last ten months (1), never (7) Mao: Weekly (3), monthly (2), two to five months (1), doesn't know (1) Los Martinez: Every two to three months (7) | Cajuco: Haven't been cleaned yet (3) Las Matas de Santa Cruz: Once a year (1) | Playa Oeste: Not reported Los Dominguez: Not cleaned yet (1) Javillar de Costambar: Never (2) |
| How Often is the filter used? | Hundidera: Daily (5), more than twice a week (4) Mao: Daily (2), more than twice a week (5) Los Martinez: Daily (3), more than twice a week (4) | Cajuco: Daily (1), more than twice weekly (2) Las Matas de Santa Cruz: Daily (2), more than twice weekly (3) | Playa Oeste: Daily (2), More than twice weekly (3) Los Dominguez: Daily (2), more than twice weekly (3) Javillar de Costambar: Daily (2), more than twice a week (2) |
| Problems with Filter | Hundidera: None (9) Mao: Floating diffuser plate (1), none (6) Los Martinez: Floating diffuser plate (1), PVC pipe clogged with sand, filter replaced (1), sand had to be changed (1), ants in filter (1), none (2) | Cajuco: None (3) Las Matas de Santa Cruz: None (5) | Playa Oeste: None (5) Los Dominguez: None (5) Javillar de Costambar: None (4) |
| Storage of Filtered Water | Hundidera: In refrigerator or freezer (4), large garbage can (1), bucket with lid (1), thermos or bucket (1), five-gallon water bottle (1) Mao: Five-gallon water bottles (1), covered garbage can (1), bucket (1), refrigerator (1), traditional water storage vessel (1), don't store (2) Los Martinez: Refrigerator (2), bucket (1), bucket with lid (1), gallon jugs (1), large drum (1), garbage can with lid (1), don't store (1) | Cajuco: Same bucket used to pour water into filter (1), safe water storage container (2) Las Matas de Santa Cruz: Gallon jug (1), five gallon water bottle (2), refrigerator (1) | Playa Oeste: In refrigerator (3), in five gallon water bottle (1), bucket with lid (1) Los Dominguez: Five-gallon water bottle (3), gallon jug (1), bucket (2) Javillar de Costambar: Five-gallon water bottle (1), refrigerator (2), bucket (1) |
| Storage Vessel Maintenance | Hundidera: Clean with chlorine or soap (4), clean with filtered water alone (3) Mao: Clean with chlorine or soap (3), clean with filtered water alone (1), don't clean storage vessels (3) Los Martinez: Clean with chlorine or soap (4), clean with filtered water alone (1), don't clean (2) | Cajuco: Clean with soap or chlorine (2) Las Matas de Santa Cruz: Clean with filtered water alone (1) | Playa Oeste: Clean with soap or chlorine (3), clean with a towel alone (1) Los Dominguez: Clean with soap or chlorine (2), clean with towel alone (2) Javillar de Costambar: Clean with soap or chlorine (3), clean with towel alone (1) |

Table 8.4: BioSand Filter and Storage Vessel Maintenance. January 2004.

| | <i>Mao</i> | <i>Dajabon</i> | <i>Puerto Plata</i> |
|-----------------------------------------|-----------------------------------------------------------------------------------------------------------------------------------------------------------------------------------------------------------------------------------------------------------------------------------------------------------------------------------------------------------------------------------------------------------------------------------------------------------------------------------|--------------------------------------------------------------------------------------------------------------------------------------------------------------------------------------------------------------|--------------------------------------------------------------------------------------------------------------------------------------------------------------------------------------------------------------------------------------------------------------------------------------------|
| How Often is the Filter Cleaned? | <p>Hundidera: Three months ago (1), twice in the last ten months (1), never (7)</p> <p>Mao: Weekly (3), monthly (2), two to five months (1), doesn't know (1)</p> <p>Los Martinez: Every two to three months (7)</p> | <p>Cajuco: Haven't been cleaned yet (3)</p> <p>Las Matas de Santa Cruz: Once a year (1)</p> | <p>Playa Oeste: Not reported</p> <p>Los Dominguez: Not cleaned yet (1)</p> <p>Javillar de Costambar: Never (2)</p> |
| How Often is the filter used? | <p>Hundidera: Daily (5), more than twice a week (4)</p> <p>Mao: Daily (2), more than twice a week (5)</p> <p>Los Martinez: Daily (3), more than twice a week (4)</p> | <p>Cajuco: Daily (1), more than twice weekly (2)</p> <p>Las Matas de Santa Cruz: Daily (2), more than twice weekly (3)</p> | <p>Playa Oeste: Daily (2), More than twice weekly (3)</p> <p>Los Dominguez: Daily (2), more than twice weekly (3)</p> <p>Javillar de Costambar: Daily (2), more than twice a week (2)</p> |
| Problems with Filter | <p>Hundidera: None (9)</p> <p>Mao: Floating diffuser plate (1), none (6)</p> <p>Los Martinez: Floating diffuser plate (1), PVC pipe clogged with sand, filter replaced (1), sand had to be changed (1), ants in filter (1), none (2)</p> | <p>Cajuco: None (3)</p> <p>Las Matas de Santa Cruz: None (5)</p> | <p>Playa Oeste: None (5)</p> <p>Los Dominguez: None (5)</p> <p>Javillar de Costambar: None (4)</p> |
| Storage of Filtered Water | <p>Hundidera: In refrigerator or freezer (4), large garbage can (1), bucket with lid (1), thermos or bucket (1), five-gallon water bottle (1)</p> <p>Mao: Five-gallon water bottles (1), covered garbage can (1), bucket (1), refrigerator (1), traditional water storage vessel (1), don't store (2)</p> <p>Los Martinez: Refrigerator (2), bucket (1), bucket with lid (1), gallon jugs (1), large drum (1), garbage can with lid (1), don't store (1)</p> | <p>Cajuco: Same bucket used to pour water into filter (1), safe water storage container (2)</p> <p>Las Matas de Santa Cruz: Gallon jug (1), five gallon water bottle (2), refrigerator (1)</p> | <p>Playa Oeste: In refrigerator (3), in five gallon water bottle (1), bucket with lid (1)</p> <p>Los Dominguez: Five-gallon water bottle (3), gallon jug (1), bucket (2)</p> <p>Javillar de Costambar: Five-gallon water bottle (1), refrigerator (2), bucket (1)</p> |

9 Laboratory Study

9.1 Introduction

Though much valuable knowledge was gained while working with BioSand filters in the Dominican Republic, the data gathered during the three-week study only provides a snapshot of filter performance. In an effort to learn more about longer-term coliform and turbidity removal, a laboratory study was designed to evaluate performance of both the BioSand filter and the Table Filter, which was studied by M. Eng student Brittany Coulburt during IAP 2004. The Table Filter and the BioSand filter are both used as forms of household-scale water treatment in Peru and the Dominican Republic (respectively), and both the Table Filter and the BioSand filter rely on a sand bed for filtration (Figure 9.1).

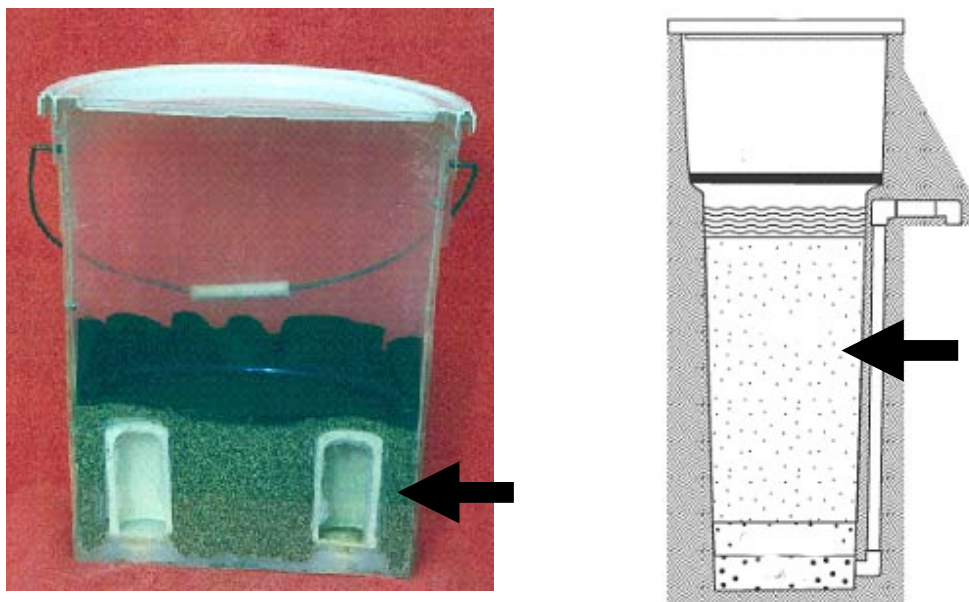

Figure 9.1: Sand Bed Location in the Table Filter (left) and the BioSand Filter (right).

Several goals were set in addition to comparing the thermotolerant coliform¹³ (TTC) and turbidity removal of the two filter types. A woven polypropylene geotextile used in the construction of the Table Filter was added to the BioSand filter in order to compare TTC and turbidity removal with and without a prefilter. This study compares TTC and turbidity rates

¹³ Thermotolerant coliform were tested in the lab using m-FC broth instead of continuing to use the m-coli Blue broth used in the Dominican Republic. The use of m-FC broth allows for lab work to be synchronized with concurrent testing in Peru during Spring 2004. M coli Blue broth was not readily and cheaply obtained in Peru, hence the switch.

between two Table Filters, one constructed with the prescribed sand¹⁴, and one constructed with sand used in BioSand filters. Details from the Table Filter sand size comparison study are available in Brittany Coulburt's Masters of Engineering Thesis.

9.2 Setup

Cleaning and Preparing the Sand

First, sand from previous experiments was removed from two plastic Davnor BioSand filters. These filters were cleaned with sterile water and allowed to dry. Three types of media were used in the filter: medium sand, small gravel, and large gravel. Medium sand was obtained from Home Depot and filtered with mosquito netting with a pore size of approximately 1 mm¹⁵. Material fitting through the mosquito netting filter was subsequently rinsed with tap water to remove any dust. The rinsing procedure consisted of placing a small amount of sand in a one-liter plastic beaker, adding water and mixing the two. The water was decanted and the clean sand was placed in a large bucket. The gravel and coarse sand were also rinsed with tap water.

Installing the Sand

After adding several inches of water, the gravel was placed in the bottom of the filters¹⁶. Gravel was added until it reached the blue line shown on the side of the Filter in Figure 9.2 (located five centimeters from the bottom of the filter). After the addition of more water (material was not added to the filter unless water was present), coarse sand was added on top of the leveled gravel. This coarse sand was leveled until it reached the orange tape on the outside of the filter (located 10 cm from the bottom of the filter), and the process was repeated with the fine sand. Fine sand was added to the filter until it reached the yellow tape (56 cm from the bottom of the filter) on the side of the filter shown in Figure 9.2.

¹⁴ Sand used in Table Filter construction should be between 0.25 mm (Tyler Mesh #60, ASTM Mesh #60, BS Mesh #60) and 0.85 mm (Tyler Mesh #20, ASTM Mesh #20, BS Mesh #18) in diameter

¹⁵ 1 mm corresponds to Tyler Mesh #18, ASTM Mesh #18, and BS Mesh #16

¹⁶ Sand is always added to water and never vice versa



Figure 9.2: BioSand filters setup during laboratory experimentation.

9.3 Procedures

Beginning February 20, each filter was fed five liters of a Charles River/municipal waste water mix seven days a week. This mix was made by diluting wastewater from the South Essex Sewerage District Wastewater Facility in Salem, MA 1:10 with water obtained from the Charles River. The mix was poured directly into the diffuser basin of both filters, but one filter's diffuser basin was lined with the geotextile. After filtration, the geotextile was removed and allowed to dry until the next day, at which point it would be placed back in the same diffuser basin and reused. Figure 9.3 shows the headspace of both filters with the diffuser basin removed. Growth in the BioSand filter without the geotextile is much more established than growth in the BioSand filter used with the geotextile filter. Twice each week, turbidity measurements and TTC tests were taken for the source water and the pause and filtered water from each filter. Methods for these two procedures have already been described in Chapter 6.

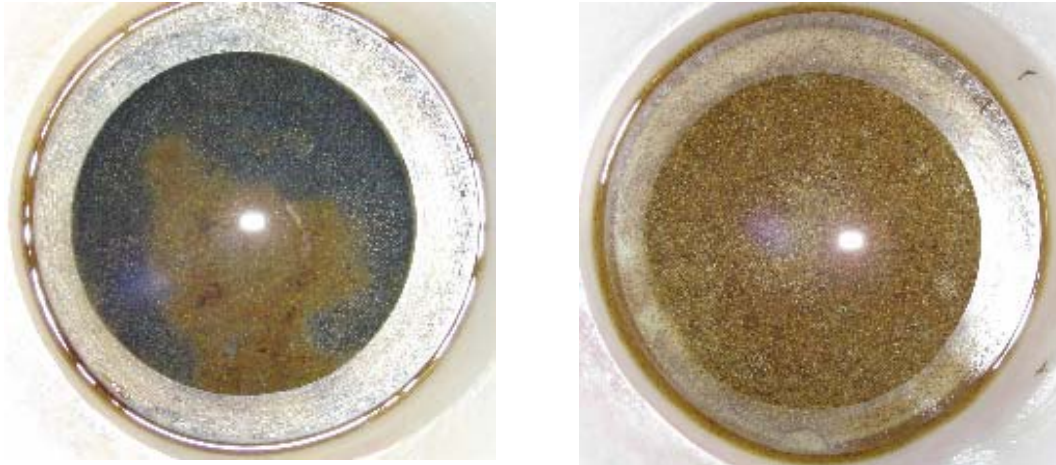

Figure 9.3: Growth in the BioSand filter's head space. Left: Without geotextile. Right: With geotextile. March 7, 2004.

9.4 Results

9.4.1 Turbidity Removal

Between 20 February 2004 and 19 March 2004, seven sets of thermotolerant coliform and turbidity measurements were taken. Figure 9.4 shows turbidity concentrations in the source water and in the effluent of the two filters. Average percent removal was 92% for both filters over the course of the experiment. Percent removal ranged from 88% and 96% for the BioSand filter used with the geotextile prefilter, and from 87% to 94% in the regular BioSand filter. Average percent removal of turbidity was 92% in both filters, and average turbidity values for the seven test dates are in Table 9.1.

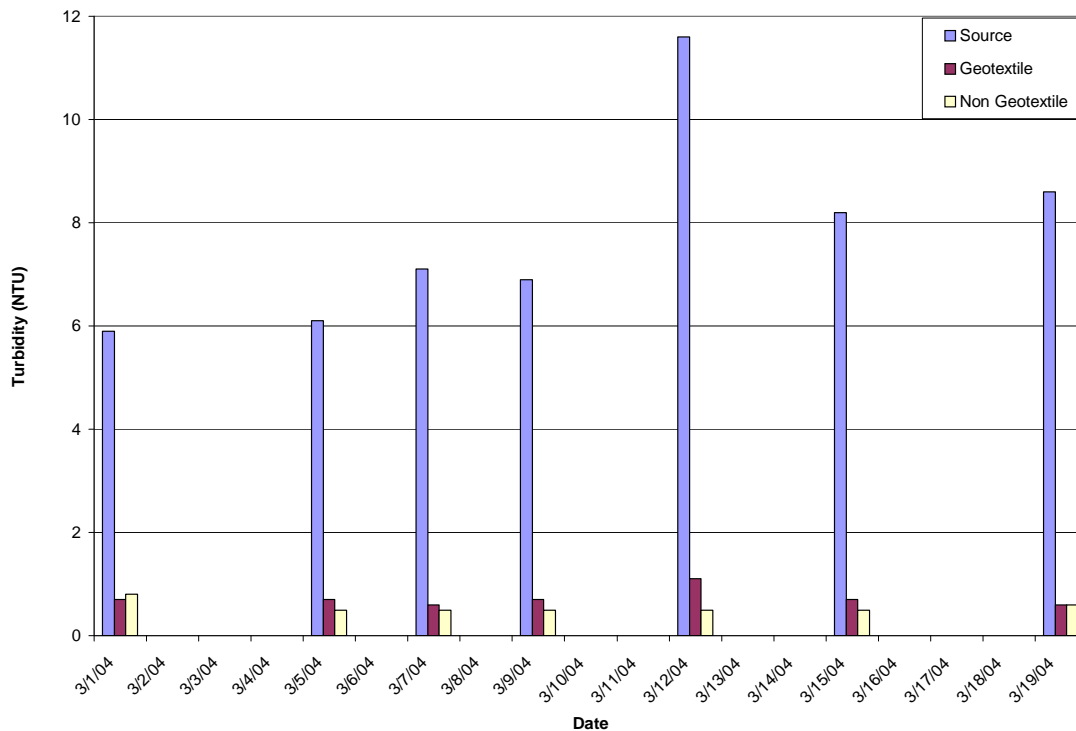

Figure 9.4: Turbidity Concentrations in Source and Filtered Water. Spring 2004.

Table 9.1: Spring 2004 Laboratory Turbidity and Percent Removal Data.

| <i>Date</i> | <i>Source Water Turbidity (NTU)</i> | <i>Geotextile Filtered Water Turbidity (NTU)</i> | <i>Non-Geotextile Filtered Water Turbidity (NTU)</i> | <i>Geotextile Percent Removal</i> | <i>Non-Geotextile Percent Removal</i> |
|----------------|-------------------------------------|--------------------------------------------------|------------------------------------------------------|-----------------------------------|---------------------------------------|
| 3/1/04 | 5.9 | 0.7 | 0.8 | 88% | 87% |
| 3/5/04 | 6.1 | 0.7 | 0.5 | 89% | 92% |
| 3/7/04 | 7.1 | 0.6 | 0.5 | 92% | 93% |
| 3/9/04 | 7.6 | 0.7 | 0.5 | 90% | 93% |
| 3/12/04 | 13.8 | 0.5 | 0.7 | 96% | 94% |
| 3/15/04 | 8.2 | 0.7 | 0.5 | 91% | 94% |
| 3/19/04 | 8.6 | 0.6 | 0.6 | 93% | 93% |
| Average | 8.2 | 0.6 | 0.6 | 92% | 92% |

9.4.2 Thermotolerant Coliform Removal

Source water had an average TTC concentration of 22,300 TTC CFU/100 ml, and concentrations ranged from 1,400 to 46,000 TTC CFU/100 ml. In the Spring 2004 laboratory study, thermotolerant coliform concentrations were always lower in filtered water than in the source

water. Filtered water from the BioSand filter without the geotextile contained an average of 970 TTC CFU/ 100 ml, and concentrations ranged from 150 to 2,125 TTC CFU/100 ml. Filtered water from the BioSand filter with the geotextile prefilter averaged 5410 TTC CFU/ 100 ml with a range from 80 to 14,300 TTC CFU/100 ml. There was a clear difference between TTC removal of the two filters. The filter without the geotextile removed an average of 90% of source water TTC while the filter with the geotextile removed an average of 80%. Percent removals of TTC for both filters are shown in Figure 8.4, and concentrations in source water and filtered water from both filters are shown in Table 8.2.

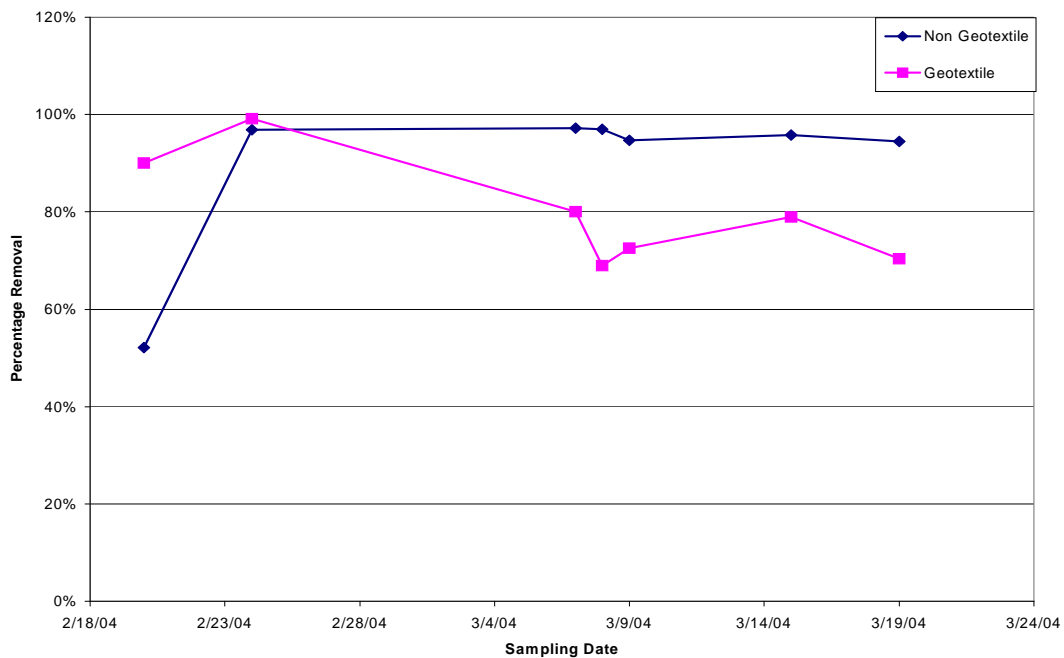

Figure 9.5: Comparison of Percent Removal of TTC by a BioSand Filter with and without a Geotextile Prefilter. Spring 2004.

Table 9.2: Source Water and Filtered Water Thermotolerant Coliform Contamination and Percent Removal.

| <i>Date</i> | <i>Source Water (TTC CFU/ 100 ml)</i> | <i>Non-Geotextile Filtered (TTC CFU/100 ml)</i> | <i>Geotextile Filtered (TTC CFU/ 100 ml)</i> | <i>Non-Geotextile Percent Removal</i> | <i>Geotextile Percent Removal</i> |
|----------------|-----------------------------------------------|---------------------------------------------------------|----------------------------------------------------------|-----------------------------------------------|-------------------------------------------|
| 2/20/2004 | 1400 | 670 | 140 | 52% | 90% |
| 2/24/2004 | 10000 | 310 | 80 | 97% | 99% |
| 3/7/2004 | 18000 | 510 | 3600 | 97% | 80% |
| 3/8/2004 | 46000 | 1400 | 14300 | 97% | 69% |
| 3/9/2004 | 40000 | 2125 | 11000 | 95% | 73% |
| 3/15/2004 | 38000 | 1600 | 8000 | 96% | 79% |
| 3/19/2004 | 2700 | 150 | 800 | 94% | 70% |
| Average | 22300 | 970 | 5410 | 90% | 80% |

10 Discussion and Conclusions

10.1 Percent Removal vs. Total Coliform Count

In our January 2004 field studies in the Dominican Republic, 15 of the 45 filters tested showed 50% or greater removal of total coliform. Even though the BioSand filter can remove a significant amount of contamination, filtered water can still contain hundreds of CFU/ 100 ml. One example is the Playa Oeste 2 filter. Source water tested at this home contained 6900 CFU/100 ml. Though the filter removed 95% of the total coliform, filtered water still contained 330 CFU/100 ml. As a comparison, the Hundidera 9 filter only removed 75% of total coliform. Source water at this location contained 40 CFU/100 ml, and filtered water contained 10 CFU/ 100 ml. The Hundidera 8 filter's source water contained 220 CFU/ 100 ml, and achieved 81% removal for a filtered water coliform concentration of 42 CFU/ 100 ml. Comparing these three filters show that it is the coliform count, not the percent removal, that is the more important descriptor of total coliform removal efficiency.

10.2 *E. coli* Removal

In our January 2004 field studies in the Dominican Republic, 24 of 43 the filters (56%) at which filtered water and source water samples were taken showed lower concentrations of *E. coli* in the filtered water. Eight of the 43 filters had *E. coli* concentrations of less than 1 CFU/100 ml in both their source and filtered water, meeting the World Health the less than one CFU/100 ml guideline set by the World Health Organization (this guideline refers to thermotolerant coliform or *E. coli*). Of the eight filters with higher *E. coli* concentrations in filtered water than in source water, three were under 10 CFU/100 ml. With respect to *E. coli* contamination, 82% of the filters tested removed or did not increase *E. coli* concentrations, providing evidence that the majority of BioSand filters tested are actively removing contamination from source waters and that the BioSand filter is a valuable tool for household-scale water treatment.

Table 10.1: Filter Affect on *E. coli* Concentration.

| Location | Lower | Same | Higher |
|-------------------------------|------------|------------|------------|
| MAO | | | |
| Hundidera (n=9) | 6 | 2 | 1 |
| Entrada de Mao (n=6) | 5 | 0 | 1 |
| Los Martinez (n=7) | 4 | 0 | 3 |
| DAJABON | | | |
| Cajuco (n=3) | 1 | 2 | 0 |
| Las Matas de Santa Cruz (n=5) | 4 | 1 | 0 |
| PUERTO PLATA | | | |
| Playa Oeste (n=6) | 2 | 3 | 1 |
| Los Dominguez (n=4) | 1 | 3 | 0 |
| Javillar de Costambar (n=3) | 1 | 0 | 2 |
| Total (n=43) | 24 | 11 | 8 |
| | 56% | 26% | 19% |

10.3 High Flow Rates and Intermittent Chlorination

High flow rates decreased total coliform removal efficiency. Average flow rates in Playa Oeste (1.4 L/min) and Javillar de Costambar (1.9 L/min) are accompanied by high total coliform concentrations in filtered water samples (four of the six filtered water samples in Playa Oeste and two of the three filtered water samples in Javillar de Costambar had total coliform counts above 2,000 CFU/100 ml). None of the filters tested in Javillar de Costambar (where high flow rates occurred) removed total coliform contamination, and two of the three filters tested had higher *E. coli* concentrations in filtered water than in source water. High flow rates can be an indication of too large sand grain size and hence of large pore size, which allows bacteria that would otherwise become trapped in the filter to pass through. The filters in Playa Oeste and Javillar de Costambar were part of a large commission of filters. The great demand for filters may not have allowed the technician constructing the filters to obtain sand from his usual source, which explains the large number of high flow rate filters in this area.

The communities of Javillar de Costambar and Playa Oeste receive tap water through the same municipal plumbing system. The water in both of these communities receives intermittent chlorination. Residual chlorination of 0.8 mg/L was measured in Javillar de Costambar, which falls within the WHO recommended range of 0.5 to 1.0 mg/L. Two homes in Playa Oeste had

source water total coliform concentrations of 0 CFU/ 100 ml, and filtered water total coliform concentrations greater than 2000 CFU/ 100 ml. Clean, chlorinated water may be poured into a filter, only to push out older, contaminated water that may have been poured in the filter earlier. Intermittent chlorination, combined with high flow rates, caused the poor filter performance in these two communities. Because no filters were tested in areas affected by only high flow rates or only by intermittent chlorination, one factor alone cannot be held more accountable for filter performance.

10.4 Storage

Total coliform tests of stored water were completed in seven locations. Four of the seven tests showed higher coliform concentrations in stored water than source water, and all but one of the storage samples had a higher total coliform count than filtered water at the same location. The one home at which total coliform concentrations did not increase between the filtration step and the storage step used a safe water storage container (Figure 10.1). The container had a spigot for dispensing water, a small opening for adding water, and is made of easily cleanable plastic. This container meets specifications outlined by the Centers for Disease Control (CDC). Multiple studies have confirmed the importance of using such containers (Quick et al. 1996, Luby et al. 2001, Reller et al. 2001), and were yet another example of their efficacy was found during the study completed in the Dominican Republic.



Figure 10.1: Safe Water Storage Container in the Dominican Republic. January 2004.

10.5 Laboratory Study

The laboratory study revealed that the BioSand filter is capable of consistently removing a significant amount of thermotolerant coliform contamination over an extended period of time. When used without a geotextile prefilter, the BioSand filter's thermotolerant coliform removal efficiency improved over the time frame of 29 days, suggesting that the period of filter ripening important to bacterial removal efficiency in large-scale slow sand filters is also at work in the BioSand filter. The use of a geotextile prefilter did not aid in thermotolerant coliform removal. Removal efficiency dropped steadily as the experiment progressed. Because source water for the two filters was identical, the geotextile prefilter may have retained something critical to thermotolerant coliform removal.

10.6 Recommendations

Though water treated by filters investigated in the Dominican Republic in January 2004 and at MIT during Spring 2004 did not reach WHO guidelines for microbial contamination of less than one CFU/100 ml (*E. coli* or thermotolerant coliform), the filters still removed significant amounts of contamination. BioSand filter users should continue using their filters, pairing BioSand filtration with post-filtration chlorination. Post-filtration chlorination will kill remaining bacteria, making the water safer to drink. The Spring 2004 laboratory study showed that using a geotextile prefilter with low turbidity water may decrease thermotolerant coliform removal efficiency. Though prefilters prolong filter life in cases of high turbidity source waters, their use may be detrimental with low turbidity source waters. The BioSand filter is, and will continue to be an effective, low-cost household-scale water treatment method.

WORKS CITED

Baker, M.N. *The Quest for Pure Water*. Vol. 1. American Water Works Association, 1982.

Bellamy, William D., David W. Hendricks, and Gary Logsdon. "Slow sand filtration: Influences of selected process variables." *Journal of the American Water Works Association* December 1985.

Burman, N. P. "Bacteriological control of slow sand filters." *Effluent and Water Treatment Journal* December 1962.

Campos, L. C., M. F. J. Su, N. J. D. Graham, and S.R. Smith. "Biomass development in slow sand filters." *Water Research* 36(2002): 4543-4551.

CAWST (Centre for Affordable Water Sanitation and Technology). Project Bravo Report. Unpublished manuscript available from CAWST. Calgary, Alberta. August 2003.

Centers for Disease Control. *Safe Water Systems for the Developing World: A Handbook for Implementing Household-Based Water Treatment and Safe Storage Projects*. Undated.

Cleasby, J. L. "Source Water Quality and Pretreatment Options for Slow Sand Filters." *Slow Sand Filtration* (G.S. Logsdon, editor). New York: ASCE, 1991.

Clesceri, L.S., A.E. Greenberg, and A.D. Dalton (eds). *Standard Methods for the Examination of Water and Wastewater 20th Edition*, 1998.

Colwell, Rita R., Anwar Huq, M. Sirajul Islam, K. M. A. Aziz, M. Yunus, N. Huda Khan, A. Mahmud, R. Bradley Sack, G.B. Nair, J. Chakraborty, David A. Sack, and E. Russek-Cohen. "Reduction of cholera in Bangladeshi villages by simple filtration." *PNAS* 100(3): 1051-1055.

Haarhoff, J. and J. L. Cleasby. "Biological and Physical Mechanisms in Slow Sand Filtration." *Slow Sand Filtration* (G.S. Logsdon, editor). New York: ASCE, 1991.

Hendricks, D. W. (Editor). *Manual of Design for Slow Sand Filtration*. Denver, CO: American Water Works Association Research Foundation, 1991.

Hendricks, D.W. and W.D. Bellamy. "Microorganism Removals by Slow Sand Filtration." *Slow Sand Filtration* (G.S. Logsdon, editor). New York: ASCE, 1991.

Huisman, L. and W.E. Wood. *Slow Sand Filtration*. WHO, Geneva, 1976. (Cited in Schulz and Okun 1984).

INDENOR (Instituto para el Desarrollo del Noroeste). *Filtros Casero de Bioarena*. Undated. Mao, Dominican Republic.

IRC/WHO. *Slow Sand Filtration for Community Water Supply in D. C. a Design and Construction Manual*. Technical Paper Series 11. Den Haag, Dez. 1978.

Lee, Tse-Luen. *Biosand Household Water Filter Project in Nepal*. MIT Masters of Engineering Thesis, 2001.

Logsdon, Gary S., Roger Kohne, Solomon Abel and Shawn LeBonde. "Slow sand filtration for small water systems." *Journal of Environmental Engineering Science* 1(2002): 339-348.

Luby S., M. Agboatwalla, A. Razz, and J. Sobel. "A low-cost intervention for cleaner drinking water in Karachi, Pakistan." *International Journal of Infectious Diseases* 2001 5(3): 144-150.

Lukacs, Heather. *From Design to Implementation: Innovative Slow Sand Filtration for use in Developing Countries*. MIT Masters of Engineering Thesis, 2002.

Madigan, Michael T., Josh. M. Martinko, and Jack Parker. *Brock Biology of Microorganisms, Ninth Edition*. Upper Saddle River, NJ: Prentice Hall, 2000.

Mintz E., J. Bartram, P. Lochery, and M. Wegelin "Not just a drop in the bucket: expanding access to point-of-use water treatment systems." *American Journal of Public Health* 2001(10): 91.

Paynter, Nathaniel C. G. *Household Water Use and Treatment Practices in Rural Nepal - BioSand Filter Evaluation & Considerations for Future Projects*. MIT Masters of Engineering Thesis, 2001,

Pincus, Melanie. *Safe Household Drinking Water via BioSand Filtration Pilot Project Evaluation and Feasibility Study of a BioSand Pitcher Filter*. MIT Masters of Engineering Thesis, 2003.

Pyper, G. R. and G. S. Logsdon. "Slow Sand Filter Design." *Slow Sand Filtration* (G.S. Logsdon, editor). New York: ASCE, 1991.

Quick R., L. Venczel, O. Gonzalez, E. Mintz, A. Highsmith, A. Espada, E. Damiani, N. Bean, R. De Hannover, and R. Tauxe. "Narrow-mouthed water storage vessels and in situ chlorination in a Bolivian community: a simple method to improve drinking water quality." *American Journal of Tropical Medicine and Hygiene* 54(1996): 511-516.

Reller, Megan E., Yves J. M. Mong, Robert M. Hoekstra, and Robert E. Quick "Cholera prevention with traditional and novel water treatment methods: an outbreak investigation in Fort-Dauphin, Madagascar." *American Journal of Public Health* 2001 91(10): 1608-1610.

Schulz, Christopher R. and Daniel J. Okun. *Surface Water Treatment for Communities in Developing Countries*. New York: Wiley, 1984.

Tollefson, J., J. Rivas, R. Hildreth, and I. de Torres. *Course for Community Facilitators of the BioSand Filter, Dominican Republic*. Unpublished document. Undated.

Van der Hoek, J.P., J. A. M. H. Hofman and A. Graveland. "Benefits of ozone-activated carbon filtration in integrated treatment processes, including membrane systems." *Aqua* 49 (2000): 341-356.

Weber-Shirk, Monroe L. "Enhancing slow sand filter performance with an acid-soluble seston extract." *Water Research* 36(2002): 4753-4756.

Weber-Shirk, Monroe L. and Richard I. Dick. "Bacterivory by a chrysophyte in slow sand filters." *Water Research* 33 (3): 631-638.

Weber-Shirk, Monroe L. and Richard I. Dick. "Physical-chemical mechanisms in slow sand filters." *Journal of the American Water Works Association* 89 (2): 87-100.

Weber-Shirk, Monroe L. and Richard I. Dick. "Biological mechanisms in slow sand filters." *Journal of the American Water Works Association* 89 (2): 72-83.

World Health Organization (WHO). *Global Water Supply and Sanitation Assessment Report*. WHO, Geneva, 2000.

WHO. *World Health Organization Guidelines for Drinking Water Quality*, 3rd Ed. Geneva: WHO, 1997.

WHO. *Water-Related Diseases*.

http://www.who.int/water_sanitation_health/diseases/diarrhoea/en/ Accessed April 2, 2004.

Appendix A: Monthly Exchange Rates¹

| | 2000 | 2001 | 2002 | 2003 | 2004 |
|------------------|--------------|--------------|--------------|--------------|-------|
| January | 15.98 | 16.62 | 17.03 | 17.56 | 46.09 |
| February | 16.05 | 16.66 | 17.15 | 18.17 | 49.23 |
| March | 16.05 | 16.66 | 17.15 | 22.72 | 46.52 |
| April | 16.05 | 16.66 | 17.56 | 23.78 | 44.38 |
| May | 16.05 | 16.66 | 17.56 | 25.60 | |
| June | 16.05 | 16.66 | 17.56 | 28.74 | |
| July | 16.05 | 16.66 | 17.56 | 34.45 | |
| August | 16.05 | 16.66 | 17.56 | 33.72 | |
| September | 16.38 | 16.66 | 17.56 | 31.70 | |
| October | 16.45 | 16.66 | 17.56 | 34.91 | |
| November | 16.489 | 16.78 | 17.56 | 39.74 | |
| December | 16.53 | 16.97 | 17.56 | 37.44 | |
| One-Year Average | 16.18 | 16.69 | 17.45 | 29.04 | |

Source: Banco Central de la Republica Dominicana (http://www.bancentral.gov.do/tasa_cambio/tasa_cambio.html).

¹All exchange rates are in Dominican pesos per US dollar

Appendix B: An English Translation of the January 2004 Survey

Background Information

1. Date of the interview
2. Complete name
3. Complete address
4. Telephone number
5. Number of people living in the house
 - Number of babies (less than two years of age)
 - Number of children (between two and 16 years of age)
 - Number of adults (greater than 16 years of age)

Before Purchasing the BioSand Filter

6. Where does your water come from?
 - If their water comes from a tap, pipe system or aqueduct, ask them if they have chlorine.
 - If they are buying their water in large five gallon jugs, ask them how many bottles they buy per week, and at what price
 - Ask about other possible sources, such as rivers and rainwater
7. Before receiving the BioSand filter, did you use any type of pretreatment? Cloth filtration? Boiling? Chlorine? Sedimentation?
8. Do you have chlorine in your house? If yes, ask about chlorine use.

The BioSand Filter

9. When did you receive your BioSand filter?
10. How much did you pay for the filter?
11. What do you use the filtered water for? Bathing? Cooking? Drinking? Clearing?
12. Are you currently using the BioSand filter for drinking water?
Is everyone living here drinking water from the BioSand filter?
If no, why not?
13. Are you sharing your filter with persons that do not live in this house?
If yes, how many babies, children and adults?
Then we have a total of __ babies, ___ children, and __ adults drinking this water from this filter, correct?
14. Are you putting chlorine in the water after filtering it? (if not answered in 8)
If yes, ask them to explain a little more.
15. Since beginning to use the BioSand filter, have you noticed positive health changes in the persons drinking this water? (Get as many details as possible)
16. Do you always drink water from the BioSand filter, or do you sometimes drink water from other sources?
17. Do you like the taste of the water from the BioSand filter?

Maintenance

18. Who maintains the filter?
19. When was the last time the filter was cleaned?
20. How many times per month is it done?
21. (Optional) How do you do it?

Water Storage

22. How many times per week do you use the filter?
23. How many liters do you filter per day? (or each time they filter)
24. How do you store the water?
25. Do you clean the collection buckets?
26. Have you had any problems with your filter? What happened? Was it ants?
A floating diffuser plate? Did you know how to fix it?

Observations

1. What type of latrine do they have (VIP/non VIP)?
2. Is there a nearby water source? Describe.
3. Cleanliness of the house/in general
4. Standing water in the yard?
5. Pets, animals
6. Where is the filter?
7. Where do they keep the bucket, is it clean
8. How do they get around?
9. Other
10. Flow rate (ml / time period)

Appendix C: Spanish Language Translation of the January 2004 Survey

Información básica

1. Fecha de la entrevista
2. Nombre completo
3. Dirección completa
4. Numero de teléfono
5. ¿Cuántas personas viven aquí?
 - Numero de bebes (menor que dos años de edad)
 - Numero de niños (entre dos y dieciséis años de edad)
 - Numero de adultos (mayor que dieciséis años de edad)

Antes de comprar el Filtro Bioarena

6. ¿De dónde viene su agua?
 - Si su agua viene por la llave, por la tubería o por el acueducto, pregúntales si tienen cloro.
 - Si compran su agua en botellones de cinco galones, pregúntales cuántos y por cual precio.
7. ¿Antes de recibir el filtro Bioarena, usaba algún tipo de tratamiento previo? ¿Lo filtraba con tela? ¿Lo hervía? ¿Usaba cloro? ¿Sedimentación?
8. ¿Usted tiene cloro en la casa? Si responde <<sí>>, pregunta sobre el uso de cloro.

El Filtro Bioarena

9. ¿Cuándo recibió usted su filtro Bioarena?
10. ¿Cuánto pagó?
11. ¿Para qué usa usted el agua? ¿Bañarse? ¿Cocinar? ¿Tomar? ¿Limpiar?
12. ¿Ustedes están usando ahora el Filtro Bioarena para el agua potable?
¿Todas las personas que viven aquí están tomando el agua del Filtro Bioarena?
Si no, ¿por qué no?
13. ¿Ustedes comparten el Filtro Bioarena con personas que no viven en esta misma casa? Si responde <<sí>>, ¿cuántos bebes, niños, y adultos?
Entonces, tenemos un total de _____ bebes, _____ niños, _____ y
adultos tomando agua de este Filtro Bioarena, ¿correcto?
14. ¿Ustedes echan cloro en el agua después de filtrarla? (if not answered in 8)
Si responde <<sí>>, pregúntale explicar un poquito más.
15. ¿Desde comenzar a usar el agua del Filtro Bioarena ¿Ha notado cambios buenos en la salud de las personas tomándola? Busca tantos detalles como sea posible.
16. ¿Ustedes toman siempre esta agua, o toman a veces el agua de otras fuentes?
17. ¿Le gusta el sabor del agua del Filtro Bioarena?

Mantenimiento

18. ¿Quién lo hace el mantenimiento?
19. ¿Cuándo fue la vez última que alguien limpió el filtro?
20. ¿Cuántos veces por mes lo hace?
21. (opcional) ¿Cómo lo hace?

Almacenaje del agua

22. Cuantos veces por semana usa el filtro?
23. ¿Cuántos litros filtra cada día? (o cuando filtra)
24. ¿Cómo se guarda el agua?
25. ¿Limpias los recipientes?
26. ¿Ha tenido algún problema con su filtro? ¿Qué pasó? ¿Había hormigas? ¿Plato difusor que flota? ¿Supo cómo arreglarlo?

Appendix D: Adjusted Total Coliform Data Including Estimated Values

| Location | Pause Water Contamination (CFU/100 ml) | Source Water Contamination (CFU/100 ml) | Filtered Water Contamination (CFU/100 ml) | Stored Water Contamination (CFU/100 ml) | Percent Removal From Source Water |
|---------------------|----------------------------------------|-----------------------------------------|-------------------------------------------|-----------------------------------------|-----------------------------------|
| MAO | | | | | |
| Hundidera 1 | 203 | 100 | 102 | 173 | -2% |
| Hundidera 2 | >2000 | >2000 | 200 | 200 | - |
| Hundidera 3 | 149 | 259 | 90 | 200 | 65% |
| Hundidera 4 | >2000 | >2000 | 200 | | - |
| Hundidera 5 | >2000 | >2000 | >200 | | - |
| Hundidera 6 | | 1390 | >200 | | 86% (max) ¹ |
| Hundidera 7 | 1310 | 1390 | >200 | | 86% (max) ¹ |
| Hundidera 8 | >200 | 220 | 42 | | 81% |
| Hundidera 9 | 620 | 40 | 10 | >200 | 75% |
| | | | | | |
| Entrada de Mao 1 | 360 | | | >200 | N/A |
| Entrada de Mao 2 | 790 | >2000 | 210 | >200 | 90% (min) ² |
| Entrada de Mao 3 | 610 | 1240 | >200 | | 84% (max) ¹ |
| Entrada de Mao 4 | >2000 | | 250 | | N/A |
| Entrada de Mao 5 | >2000 | >2000 | >200 | | - |
| Entrada de Mao 6 | >2000 | >2000 | >200 | | - |
| Entrada de Mao 7 | | >2000 | >200 | | - |
| Entrada de Mao 8 | >2000 | >2000 | >200 | | - |
| | | | | | |
| Los Martinez 1 | >2000 | >2000 | >200 | | - |
| Los Martinez 2 | >2000 | >2000 | >200 | | - |
| Los Martinez 3 | >2000 | >2000 | >200 | | - |
| Los Martinez 4 | >2000 | >2000 | >200 | >200 | - |
| Los Martinez 5 | >2000 | >2000 | >200 | | - |
| Los Martinez 6 | >2000 | >2000 | >200 | | - |
| Los Martinez 7 | >2000 | >2000 | >200 | | - |
| | | | | | |
| DAJABON | | | | | |
| Cajuco 1 | 2060 | 2300 | 790 | | 66% |
| Cajuco 2 | 30 | 10 | 20 | 0 | -100% |
| Cajuco 3 | 40 | 3500 | 380 | 130 | 89% |
| | | | | | |
| Las Matas 1 | >20000 | >20000 | >2000 | >2000 | - |
| Las Matas 2 | >20000 | >2000 | >2000 | | 0% |
| Las Matas 3 | >20000 | 4700 | 2040 | | 57% |
| Las Matas 4 | 0 | 100 | >2000 | | -1900% |
| Las Matas 5 | 7100 | >20000 | 29 | | 100% |
| | | | | | |
| PUERTO PLATA | | | | | |
| Playa Oeste 1 | 8700 | >20000 | >2000 | | - |
| Playa Oeste 2 | >2000 | 690 | 330 | | 52% (min) ² |

| | | | | | |
|-------------------------|--------|--------|-------|------|--------------------------|
| Playa Oeste 3 | 756 | 0 | >2000 | | N/A |
| Playa Oeste 4 | 4200 | 17400 | >2000 | | 89% (max) ¹ |
| Playa Oeste 5 | 556 | >20000 | 0 | | 100% |
| Playa Oeste 6 | 16200 | 0 | >2000 | | N/A |
| | | | | | |
| Los Dominguez 1 | 3200 | 2120 | 2130 | | 0% |
| Los Dominguez 2 | 289 | 294 | 890 | 4000 | -203% |
| Los Dominguez 3 | 740 | 211 | >4000 | | -251% |
| Los Dominguez 4 | 189 | 1720 | 690 | | 60% |
| | | | | | |
| Javillar de Costambar 2 | 4400 | 400 | >2000 | | -400% |
| Javillar de Costambar 3 | | 51 | >200 | | -292% (max) ¹ |
| Javillar de Costambar 5 | >20000 | 580 | >2000 | | -245% (max) ¹ |

¹“max” indicates the use of an estimate for filtered water contamination.

²“min” indicates the use of an estimate for source water contamination. Estimation methods are explained in Chapter 7.

Appendix E: Total Coliform Data¹⁷

| Filter | Date | Sample | Volume Filtered (ml) | Total Coliform (CFU/ plate) | Total Coliform (CFU/100 ml) |
|-------------|----------|----------|----------------------|-----------------------------|-----------------------------|
| MAO | | | | | |
| Hundidera 1 | 1/8/2004 | Pause | 100 | 203 | 203 |
| | 1/8/2004 | Source | 10 | 10 | 100 |
| | 1/8/2004 | Filtered | 100 | 102 | 102 |
| | 1/8/2004 | Stored | 100 | 173 | 173 |
| Hundidera 2 | 1/8/2004 | Pause | 10 | 962 | 9620 |
| | 1/8/2004 | Source | 10 | 273 | 2730 |
| | 1/8/2004 | Filtered | 100 | 2970 | 2970 |
| | 1/8/2004 | Stored | 100 | 29700 | 29700 |
| Hundidera 3 | 1/8/2004 | Pause | 100 | 149 | 149 |
| | 1/8/2004 | Source | 100 | 259 | 259 |
| | 1/8/2004 | Filtered | 100 | 90 | 90 |
| | 1/8/2004 | Stored | 100 | 287 | 287 |
| Hundidera 4 | 1/8/2004 | Pause | 10 | 731 | 7310 |
| | 1/9/2004 | Source | 10 | 516 | 5158 |
| | 1/8/2004 | Filtered | 100 | 341 | 341 |
| Hundidera 5 | 1/8/2004 | Pause | 10 | TNTC | TNTC |
| | 1/8/2004 | Source | 10 | TNTC | TNTC |
| | 1/8/2004 | Filtered | 100 | 378 | 378 |
| Hundidera 6 | 1/8/2004 | Source | 10 | 139 | 1390 |
| | 1/8/2004 | Filtered | 100 | 881 | 881 |
| Hundidera 7 | 1/8/2004 | Pause | 10 | 131 | 1310 |
| | 1/8/2004 | Source | 10 | 139 | 1390 |
| | 1/8/2004 | Filtered | 100 | 590 | 590 |
| Hundidera 9 | 1/8/2004 | Pause | 10 | 62 | 620 |
| | 1/8/2004 | Source | 10 | 4 | 40 |
| | 1/8/2004 | Filtered | 100 | 10 | 10 |
| | 1/8/2004 | Stored | 100 | 848 | 848 |
| Hundidera 8 | 1/8/2004 | Pause | 100 | 624 | 624 |
| | 1/8/2004 | Source | 10 | 22 | 220 |
| | 1/8/2004 | Filtered | 100 | 42 | 42 |
| Mao 1 | 1/9/2004 | Source | 10 | 36 | 360 |
| | 1/9/2004 | Stored | 100 | TNTC | TNTC |
| Mao 2 | 1/9/2004 | Pause | 10 | 79 | 790 |
| | 1/9/2004 | Source | 10 | 1093 | 10934 |
| | 1/9/2004 | Filtered | 100 | 210 | 210 |
| | 1/9/2004 | Stored | 100 | 598 | 598 |
| Mao 3 | 1/9/2004 | Pause | 10 | 61 | 610 |
| | 1/9/2004 | Source | 10 | 124 | 1240 |
| | 1/9/2004 | Filtered | 100 | 349 | 349 |

¹⁷ Counts over 200 were estimated by counting a fraction of the plate and multiplying that count by the reciprocal of that fraction.

| | | | | | |
|----------------|-----------|----------|-----|------|-------|
| Mao 4 | 1/9/2004 | Pause | 10 | 631 | 6313 |
| | 1/9/2004 | Filtered | 80 | 1112 | 1390 |
| Mao 5 | 1/9/2004 | Pause | 10 | 1450 | 14500 |
| | 1/9/2004 | Source | 10 | 293 | 2930 |
| | 1/9/2004 | Filtered | 100 | 1467 | 1467 |
| Mao 6 | 1/9/2004 | Pause | 10 | 667 | 6670 |
| | 1/9/2004 | Source | 10 | 1483 | 14830 |
| | 1/9/2004 | Filtered | 100 | 500 | 500 |
| Mao 7 | 1/9/2004 | Source | 10 | TNTC | TNTC |
| | 1/9/2004 | Filtered | 100 | 1189 | 1189 |
| Mao 8 | 1/9/2004 | Pause | 10 | 3010 | 30100 |
| | 1/9/2004 | Source | 10 | 2068 | 20680 |
| | 1/9/2004 | Filtered | 100 | 1080 | 1080 |
| Los Martinez 1 | 1/10/2004 | Pause | 10 | 843 | 8430 |
| | 1/10/2004 | Source | 10 | TNTC | TNTC |
| | 1/10/2004 | Filtered | 100 | 398 | 398 |
| Los Martinez 2 | 1/10/2004 | Pause | 10 | 1751 | 17510 |
| | 1/10/2004 | Source | 10 | 982 | 9820 |
| | 1/10/2004 | Filtered | 100 | 551 | 551 |
| Los Martinez 3 | 1/10/2004 | Pause | 10 | 1296 | 12960 |
| | 1/10/2004 | Source | 10 | 235 | 2350 |
| | 1/10/2004 | Filtered | 100 | 2002 | 2002 |
| Los Martinez 4 | 1/10/2004 | Pause | 10 | 2007 | 20070 |
| | 1/10/2004 | Source | 10 | 1394 | 13940 |
| | 1/10/2004 | Filtered | 100 | 922 | 922 |
| | 1/10/2004 | Stored | 100 | 1870 | 1870 |
| Los Martinez 5 | 1/10/2004 | Pause | 10 | 4668 | 46680 |
| | 1/10/2004 | Source | 10 | 2667 | 26670 |
| | 1/10/2004 | Filtered | 100 | 2133 | 2133 |
| Los Martinez 6 | 1/10/2004 | Pause | 10 | TNTC | TNTC |
| | 1/10/2004 | Source | 10 | 207 | 2070 |
| | 1/10/2004 | Filtered | 100 | TNTC | TNTC |
| Los Martinez 7 | 1/10/2004 | Pause | 10 | 2442 | 24420 |
| | 1/10/2004 | Source | 10 | 1193 | 11930 |
| | 1/10/2004 | Filtered | 100 | 2887 | 2887 |
| DAJABON | | | | | |
| Cajuco 1 | 1/14/2004 | Pause | 10 | 206 | 2060 |
| | 1/14/2004 | Source | 1 | 23 | 2300 |
| | 1/14/2004 | Filtered | 10 | 79 | 790 |
| Cajuco 2 | 1/14/2004 | Pause | 10 | 3 | 30 |
| | 1/14/2004 | Source | 10 | 1 | 10 |
| | 1/14/2004 | Filtered | 10 | 2 | 20 |
| | 1/14/2004 | Stored | 10 | 0 | 0 |
| Cajuco 3 | 1/14/2004 | Pause | 10 | 4 | 40 |
| | 1/14/2004 | Source | 1 | 35 | 3500 |
| | 1/14/2004 | Filtered | 10 | 38 | 380 |
| | 1/14/2004 | Stored | 10 | 13 | 130 |

| | | | | | |
|---------------------------|-----------|----------|----|------|--------|
| Las Matas de Santa Cruz 1 | 1/15/2004 | Pause | 1 | 512 | 51200 |
| | 1/15/2004 | Source | 1 | 1019 | 101850 |
| | 1/15/2004 | Filtered | 10 | 86 | 860 |
| | 1/15/2004 | Stored | 10 | TNTC | TNTC |
| Las Matas de Santa Cruz 2 | 1/15/2004 | Pause | 1 | 1310 | 131000 |
| | 1/15/2004 | Source | 10 | TNTC | TNTC |
| | 1/15/2004 | Filtered | 10 | 1831 | 18310 |
| Las Matas de Santa Cruz 3 | 1/15/2004 | Pause | 1 | 723 | 72300 |
| | 1/15/2004 | Source | 1 | 47 | 4700 |
| | 1/15/2004 | Filtered | 10 | 204 | 2040 |
| Las Matas de Santa Cruz4 | 1/15/2004 | Pause | 9 | 0 | 0 |
| | 1/15/2004 | Source | 1 | 1 | 100 |
| | 1/15/2004 | Filtered | 10 | 317 | 3170 |
| Las Matas de Santa Cruz 5 | 1/15/2004 | Pause | 1 | 71 | 7100 |
| | 1/15/2004 | Source | 1 | 503 | 50300 |
| | 1/15/2004 | Filtered | 10 | 29 | 290 |
| PUERTO PLATA | | | | | |
| Playa Oeste 1 | 1/20/2004 | Pause | 1 | 87 | 8700 |
| | 1/20/2004 | Source | 1 | 3136 | 313600 |
| | 1/20/2004 | Filtered | 10 | 880 | 8800 |
| Playa Oeste 2 | 1/20/2004 | Pause | 10 | 912 | 9120 |
| | 1/20/2004 | Source | 1 | 69 | 6900 |
| | 1/20/2004 | Filtered | 10 | 33 | 330 |
| Playa Oeste 3 | 1/20/2004 | Pause | 9 | 68 | 756 |
| | 1/20/2004 | Source | 9 | 0 | 0 |
| | 1/20/2004 | Filtered | 10 | 530 | 5300 |
| Playa Oeste 4 | 1/20/2004 | Pause | 1 | 42 | 4200 |
| | 1/20/2004 | Source | 1 | 174 | 17400 |
| | 1/20/2004 | Filtered | 10 | 238 | 2380 |
| Playa Oeste 5 | 1/20/2004 | Pause | 9 | 50 | 556 |
| | 1/20/2004 | Source | 1 | 279 | 27900 |
| | 1/20/2004 | Filtered | 10 | 0 | 0 |
| Playa Oeste 6 | 1/20/2004 | Pause | 1 | 162 | 16200 |
| | 1/20/2004 | Source | 9 | 0 | 0 |
| | 1/20/2004 | Filtered | 10 | 387 | 3870 |
| Los Dominguez 1 | 1/21/2004 | Pause | 1 | 32 | 3200 |
| | 1/21/2004 | Source | 5 | 106 | 2120 |
| | 1/21/2004 | Filtered | 10 | 213 | 2130 |
| Los Dominguez 2 | 1/21/2004 | Pause | 9 | 26 | 289 |
| | 1/21/2004 | Source | 50 | 147 | 294 |
| | 1/21/2004 | Filtered | 10 | 89 | 890 |
| | 1/21/2004 | Stored | 5 | 1392 | 27830 |
| Los Dominguez 3 | 1/21/2004 | Pause | 9 | 19 | 211 |
| | 1/21/2004 | Source | 5 | 37 | 740 |
| | 1/21/2004 | Filtered | 10 | 376 | 3760 |
| Los Dominguez 4 | 1/21/2004 | Pause | 9 | 17 | 189 |
| | 1/21/2004 | Source | 5 | 86 | 1720 |

| | | | | | |
|-------------------------|-----------|----------|-----|------|-------|
| | 1/21/2004 | Filtered | 10 | 69 | 690 |
| Javillar de Costambar 2 | 1/22/2004 | Pause | 1 | 44 | 4400 |
| | 1/22/2004 | Source | 5 | 297 | 5940 |
| | 1/22/2004 | Filtered | 10 | 711 | 7110 |
| Javillar de Costambar 3 | 1/22/2004 | Source | 80 | 41 | 51 |
| | 1/22/2004 | Filtered | 100 | 4455 | 4455 |
| Javillar de Costambar 5 | 1/22/2004 | Pause | 1 | 267 | 26700 |
| | 1/22/2004 | Source | 5 | 29 | 580 |
| | 1/22/2004 | Filtered | 10 | 1230 | 12300 |

Appendix F: *E. coli* Contamination

| Location | Pause Water Contamination (CFU/100 ml) | Source Water Contamination (CFU/100 ml) | Filtered Water Contamination (CFU/100 ml) | Stored Water Contamination (CFU/100 ml) | Percent Removal from Source Water |
|---------------------|----------------------------------------|-----------------------------------------|-------------------------------------------|-----------------------------------------|-----------------------------------|
| MAO | | | | | |
| Hundidera 1 | 3 | 0 | 6 | 15 | N/A |
| Hundidera 2 | >2000 | >2000 | >200 | >200 | - |
| Hundidera 3 | 3 | 1 | 0 | 1 | 100% |
| Hundidera 4 | 100 | 190 | 11 | | 94% |
| Hundidera 5 | 10 | 60 | 11 | | 82% |
| Hundidera 6 | | 10 | 1 | | 90% |
| Hundidera 7 | 20 | 30 | 3 | | 90% |
| Hundidera 8 | 0 | 0 | 0 | | - |
| Hundidera 9 | 0 | 0 | 0 | | - |
| | | | | | |
| Entrada de Mao 1 | | | | 200 | N/A |
| Entrada de Mao 2 | 0 | 500 | 0 | 4 | 100% |
| Entrada de Mao 3 | 20 | 10 | 13 | | -30% |
| Entrada de Mao 4 | 0 | - | 3 | | N/A |
| Entrada de Mao 5 | 70 | 30 | 1 | | 97% |
| Entrada de Mao 6 | 0 | 30 | 0 | | 100% |
| Entrada de Mao 7 | | 880 | 23 | | 97% |
| Entrada de Mao 8 | 30 | 60 | 13 | | 78% |
| | | | | | |
| Los Martinez 1 | 0 | 10 | 6 | | 40% |
| Los Martinez 2 | 350 | 60 | 5 | | 92% |
| Los Martinez 3 | 10 | 0 | 4 | | N/A |
| Los Martinez 4 | 0 | 10 | 6 | 2 | 40% |
| Los Martinez 5 | 60 | 30 | 24 | | 20% |
| Los Martinez 6 | >2000 | 10 | 71 | | -610% |
| Los Martinez 7 | 0 | 0 | 1 | | N/A |
| | | | | | |
| DAJABON | | | | | |
| Cajuco 1 | 0 | 0 | 0 | | - |
| Cajuco 2 | 0 | 0 | 0 | 0 | - |
| Cajuco 3 | 0 | 800 | 100 | | 88% |
| | | | | | |
| Las Matas 1 | 0 | 100 | 0 | 50 | 100% |
| Las Matas 2 | 0 | 40 | 10 | | 75% |
| Las Matas 3 | 0 | >200 | 0 | | 100% |
| Las Matas 4 | 0 | 0 | 0 | | - |
| Las Matas 5 | 100 | 300 | 0 | | 100% |
| | | | | | |
| PUERTO PLATA | | | | | |
| Playa Oeste 1 | 0 | 100 | 0 | | 100% |

| | | | | | |
|-------------------------|------|-----|-------|----|-------|
| Playa Oeste 2 | 0 | 0 | 0 | | - |
| Playa Oeste 3 | 0 | 0 | >2000 | | - |
| Playa Oeste 4 | 0 | 100 | 0 | | 100% |
| Playa Oeste 5 | 11 | 0 | 0 | | - |
| Playa Oeste 6 | 100 | 0 | 0 | | - |
| | | | | | |
| Los Dominguez 1 | 0 | 0 | 0 | | - |
| Los Dominguez 2 | 11 | 0 | 0 | 80 | - |
| Los Dominguez 3 | 178 | 0 | 0 | | - |
| Los Dominguez 4 | 0 | 40 | 20 | | 50% |
| | | | | | |
| Javillar de Costambar 2 | 0 | 20 | 0 | | 100% |
| Javillar de Costambar 3 | | 0 | 15 | | N/A |
| Javillar de Costambar 5 | 4700 | 20 | 90 | | -350% |